

omniace  
RA3100

DATA ACQUISITION SYSTEM



All data recorded in Omniace  
High-speed, long-term recording of phenomena  
on large-capacity storage media

Data Acquisition System

omniace RA3100



Omniace RA3100 is a data acquisition system for research, development, and field maintenance, which enables accurate and long-term measurement of high-speed switching waveforms, even in severely noisy environments, in electric automobiles, electronic appliances, railroad cars, and solar power generation systems utilizing inverter control technology that has become widespread in recent years.

<b>Multi-channel input</b>	Max 36ch (analog input) Max 144ch (logic input)
<b>High speed sampling</b>	Max 20MS/s
<b>Long-term recording</b>	Memory capacity 4GB (when 18 channels are used, 20MS/s, 5 seconds) 256GB SSD (1MS/s, 59 minutes when using 36 channels.)
<b>High-speed and High-definition printing</b>	Maximum chart speed 100mm/s Back up to SSD even if there is no chart paper.
<b>Various recording method</b>	Recording to Memory, SSD, and Printer. All data can be measured simultaneously.
<b>Input modules</b>	Voltage,High-Voltage(1,000V), Temperature, Strain,Acceleration,Pulse and Logic Input Module
<b>Excellent visibility and operability</b>	12.1-inch LCD with touch panel provide you excellent visibility and operability.
<b>Back scrolling</b>	Data being measured can be played back without ending the measurement.
<b>Various Monitor Displays</b>	Y-T waveform, X-Y waveform, and FFT analysis can be displayed on the LCD monitor during measurement.

# High-speed Sampling and High-definition Measurement at 20MS/s with 18ch for 5 seconds

"The 2ch High-Speed Voltage Module" is an input module for high-speed sampling at the highest level of the series. Includes the ability for a sampling rate of 20MS/s, input voltage up to  $\pm 500V$ , and 14bit resolution. 9 modules can be installed in the main unit, allowing for 18-channel high-speed memory recording.

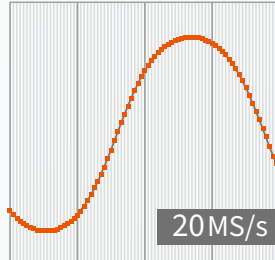
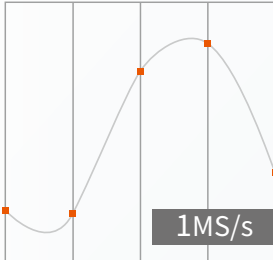

## Recordable time into memory

	2ch	8ch	18ch
20 MS/s	50sec	10sec	5sec
10 MS/s	1 min 40sec	20sec	10sec
5 MS/s	3 min 20sec	40sec	20sec
2 MS/s	8 min 20sec	1 min 40sec	50sec
1 MS/s	16 min 40sec	3 min 20sec	1 min 40sec
500 kS/s	33 min 20sec	6 min 40sec	3 min 20sec
10 kS/s	27 hrs 46 min 40sec	5 hrs 33 min 20sec	2 hrs 46 min 40sec
5 kS/s	55 hrs 33 min 20sec	11 hrs 06 min 40sec	5 hrs 33 min 20sec
2 kS/s	138 hrs 53 min 20sec	27 hrs 46 min 40sec	13 hrs 53 min 20sec
1 kS/s	277 hrs 46 min 40sec	55 hrs 33 min 20sec	27 hrs 46 min 40sec

## Long-term Recording

Various recording speeds, multiple channels, and a high-capacity storage medium to support a large amount of data are included as standard.

Recording desired signal accurately without missing detailed changes.

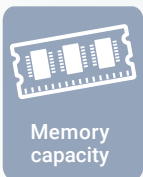

**4GB**

(when 18 channels are used, 20MS/s, 5 seconds)

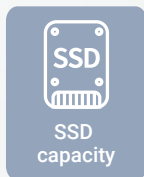

**256GB**

(when 36 channels are used, 1MS/s, 59 minutes)



## High-speed, High-definition Printing

High-resolution waveform printing at high speeds (100mm/s) is possible.

Even if the chart paper runs out, recorded data is backed up to the SSD and can be printed out later.

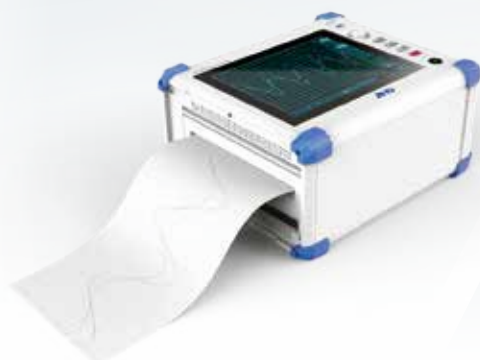

## Multi-channel Input

"The 4ch Voltage Module" allows 4-channel input with a single unit. 9 modules can be installed in the main unit, allowing 36-channel recording.

"The 16-channel Logic Module" allows 16-channel logic signal input with a single unit. 9 modules can be installed in the main unit, allowing 144-channel logic signal recording.

**Max 36ch**  
with analog input

**Max 144ch**  
with logic input

# Excellent Visibility and Operability

The LCD display with touch panel allows zoom in and out, and scrolling through the waveform simply, allowing a dynamic waveform drawing and operability like a smartphone.



Pinch-in (zoom out)



Pinch-out (zoom in)



Swipe (scroll)

## Input Module

Up to 9 modules can be installed in the main unit. Various modules for high-speed voltage, high-accuracy voltage, logic input, temperature measurement, and remote control are available.



2ch Voltage Module  
RA30-101



4ch Voltage Module ( $\pm 200V$ )  
RA30-102



4ch Voltage Module ( $\pm 500V$ )  
RA30-113



2ch High-speed Voltage Module  
RA30-103



2ch High-Voltage Module  
RA30-107



2ch Temperature Module  
RA30-106



2ch AC Strain Module  
RA30-104



2ch Acceleration Module  
RA30-109



2ch Frequency Module  
RA30-108



16ch Logic Module  
RA30-105

Module Name and Model	Channels	Sampling Rate	Input	Specifications
2ch Voltage Module RA30-101	2ch	1MS/s	Voltage $\pm 500V$	Measure high-speed voltage measurement with anti-aliasing filters
4ch Voltage Module RA30-102	4ch	1MS/s	Voltage $\pm 200V$	Multi-channel voltage measurement
4ch Voltage Module RA30-113	4ch	1MS/s	Voltage $\pm 500V$	Multi-channel voltage measurement
2ch High-speed Voltage Module RA30-103	2ch	20MS/s	Voltage $\pm 500V$	High-speed voltage measurement
2ch High Voltage Module RA30-107	2ch	1MS/s	Voltage $\pm 1,000V$	Module to measure high voltages of $\pm 1,000V$
16ch Logic Module RA30-105	16ch	1MS/s	Contact, Voltage	Contact, Voltage signal measurement
2ch Temperature Module RA30-106	2ch	1.5ms	Thermocouple: K, E, J, T, N, R, S, B, C RTD: Pt100, Pt1000	Measurement of temperature with a thermocouple and RTD
2ch AC Strain Module RA30-104	2ch	100kS/s	Strain gauge, Strain gauge transducer	Module to measure stress, load, displacement, pressure, torque, and acceleration
2ch Acceleration Module RA30-109	2ch	1MS/s	Piezoelectric acceleration transducer (charge output, built-in amplifier)	Module to measure acceleration, speed and displacement
2ch Frequency Module RA30-108	2ch	1MS/s	Voltage $\pm 500V$	Input module capable of measuring period, rotation speed, number of pulses, etc., of input signals

## Back Scrolling

Press the [PAUSE] button during recording to playback recorded data while recording.

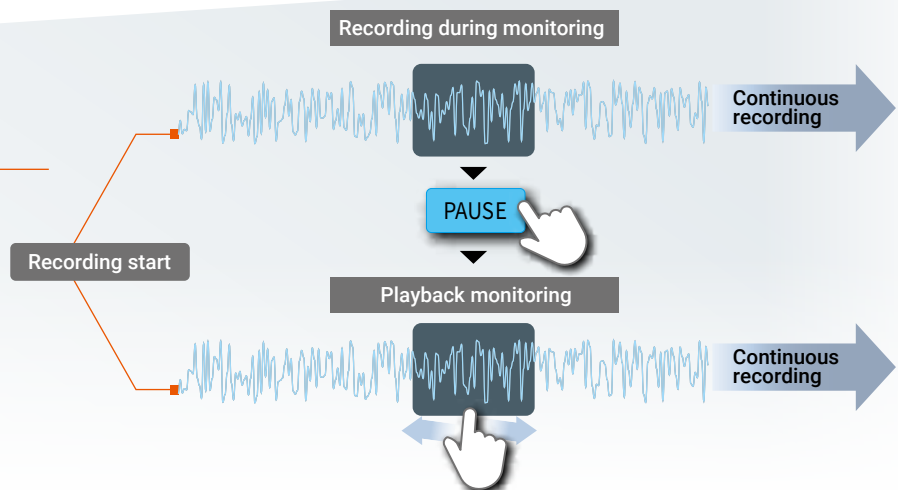

# Various Recording Method

"Memory", "SSD", and "Printer" are provided as data recording destinations. Data recording can be performed at three destinations at the same time. This can be selected freely depending on the measurement purposes.

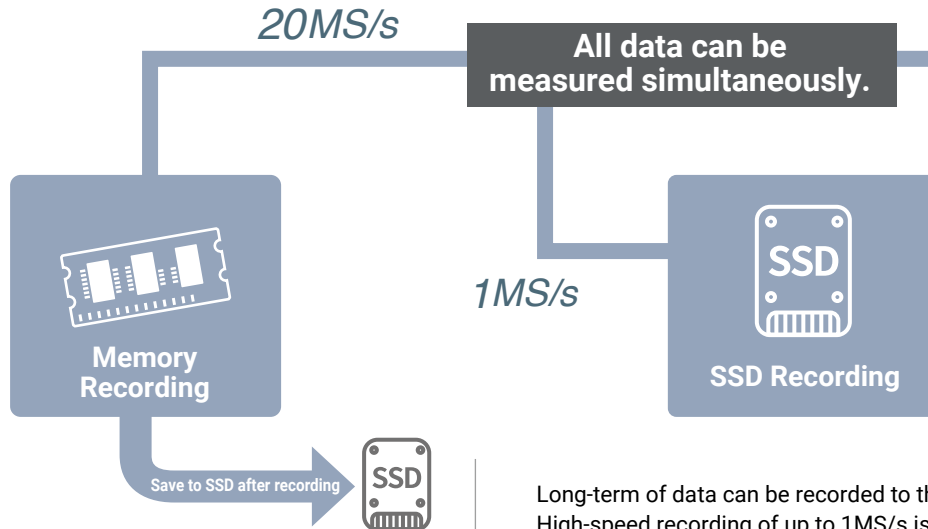

Memory mode records data in the internal memory (4GB) at high speed (Max: 20MS/s). In addition, measurement can be performed under a variety of conditions using a variety of trigger functions.

After the input data is recorded in the memory, it is automatically saved to SSD.

- Sampling speed** : 20MS/s to 10S/min (depending on the input module)
- Memory capacity** : 4GB (2G point/ch)
- Memory divisions** : 1 to 200 divisions
- Recording length** : 2,000 to 2G points/ch (1-2-5 step)

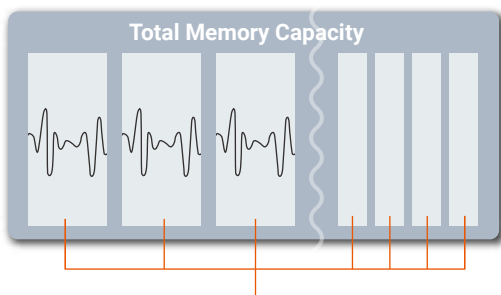

**Memory Block Segment**  
1~200

## Recordable Time on Memory

	2ch	8ch	18ch	36ch
20MS/s	50 sec	10 sec	5 sec	—
10MS/s	1 min 40 sec	20 sec	10 sec	5 sec
5MS/s	3 min 20 sec	40 sec	20 sec	10 sec
2MS/s	8 min 20 sec	1 min 40 sec	50 sec	25 sec
1MS/s	16 min 40 sec	3 min 20 sec	1 min 40 sec	50 sec
500kS/s	33 min 20 sec	6 min 40 sec	3 min 20 sec	1 min 40 sec
10kS/s	27 hrs 46 min 40 sec	5 hrs 33 min 20 sec	2 hrs 46 min 40 sec	1 hr 23 min 20 sec
5kS/s	55 hrs 33 min 20 sec	11 hrs 06 min 40 sec	5 hrs 33 min 20 sec	2 hrs 46 min 40 sec
2kS/s	138 hrs 53 min 20 sec	27 hrs 46 min 40 sec	13 hrs 53 min 20 sec	6 hrs 56 min 40 sec
1kS/s	277 hrs 46 min 40 sec	55 hrs 33 min 20 sec	27 hrs 46 min 40 sec	13 hrs 53 min 20 sec

Long-term of data can be recorded to the internal SSD. High-speed recording of up to 1MS/s is possible when using 36ch. Since it is stored as digital data, data can be analyzed after recording and data can be managed for a long period of time.

Input data is saved directly to SSD.

- Sampling speed** : 1MS/s to 10S/min (depending on the input module)
- SSD capacity** : 256GB
- Maximum recording time** : 100 days
- Data format** : Normal data, Peak data

## Recordable Time on SSD\*1

Sample speed	2ch	8ch	18ch	36ch
*2 1 MS/s	11hrs 46min 40sec	3hrs 55min 33sec	1hrs 51min 34sec	57min 17sec
500 kS/s	23hrs 33min 21sec	7hrs 51min 07sec	3hrs 43min 09sec	1hrs 54min 35sec
200 kS/s	2day 11hrs 20min 02sec	19hrs 37min 48sec	9hrs 17min 54sec	4hrs 46min 29sec
100 kS/s	4day 21hrs 46min 49sec	1day 15hrs 15min 36sec	18hrs 35min 48sec	9hrs 32min 59sec
50 kS/s	9day 19hrs 33min 39sec	3day 06hrs 31min 13sec	1day 13hrs 11min 37sec	19hrs 05min 58sec
20 kS/s	24day 12hrs 54min 09sec	8day 04hrs 18min 03sec	3day 20hrs 59min 04sec	1day 23hrs 44min 55sec
10 kS/s	49day 01hrs 48min 19sec	16day 08hrs 36min 06sec	7day 17hrs 58min 09sec	3day 23hrs 29min 51sec
5 kS/s	98day 03hrs 36min 38sec	32day 17hrs 12min 12sec	15day 11hrs 56min 18sec	7day 22hrs 59min 43sec
2 kS/s	100 day	81day 19hrs 00min 31sec	38day 17hrs 50min 46sec	19day 21hrs 29min 19sec
1 kS/s	100 day	100 day	77day 11hrs 41min 33sec	39day 18hrs 58min 38sec
500 S/s	100 day	100 day	100 day	79day 13hrs 57min 16sec
200 S/s	100 day	100 day	100 day	100 day

\*1 If you select peak data as the data type, the time will be 1/2 of the above time.  
\*2 A sample rate of 1 MS/s is not available when peak data is selected as the data type.

## Window Recording

Endless recording is possible by specifying the ring buffer area (maximum 2G points/ch) as the window recording time. If you do not know when an abnormality will occur, you may miss the abnormal data if you set the recording time and measure. By ringing the recording area, you can always save the latest data.

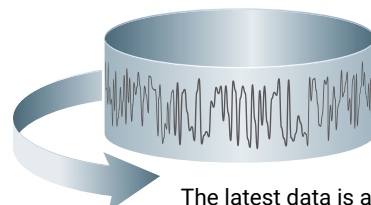

The latest data is always recorded.

100mm/s (1kS/s)



Input data is printed directly on the chart paper at high speed (Max 100mm/s). Data printed on chart paper is also stored digitally on the SSD, so even if the chart paper runs out, the data can be printed out later.

Pen recording is only recorded on the recording paper, measurement data is not saved. Input module and paper feed speed can be set during recording. Furthermore, recording to memory, SSD, and printer cannot be performed simultaneously.

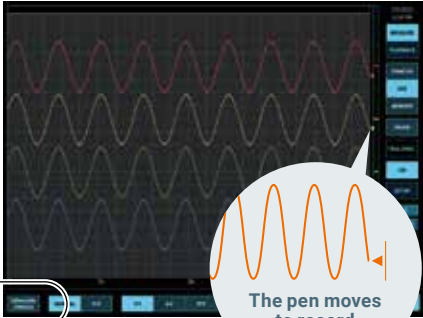

**Chart Speed**

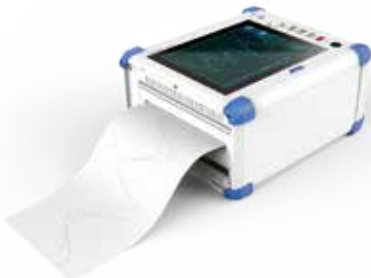

**Recording Specifications**

- Number of recorded signals: 48 channels
- Chart speed: 100mm/s(1kS/s) ~1mm/min(10S/min)
- Recording resolution: 20 to 80dots/mm (time axis) 8dots/mm (amplitude axis)

**Selectable for SSD Recording**

**Normal Data and Peak Data**

Omniace is a digital recorder that performs analog to digital conversion on all inputs and records those signals. Due to the relationship between the speed of analog to digital conversion and the frequency component of the input signal, the data may or may not be measured correctly.

**Normal Data**

Normal data is recorded at each designated sampling speed. (□ points)  
 If the signal changes too fast relative to the sampling speed, the data singular point (peak value) may not be recorded. Memory recording can measure this type of data.

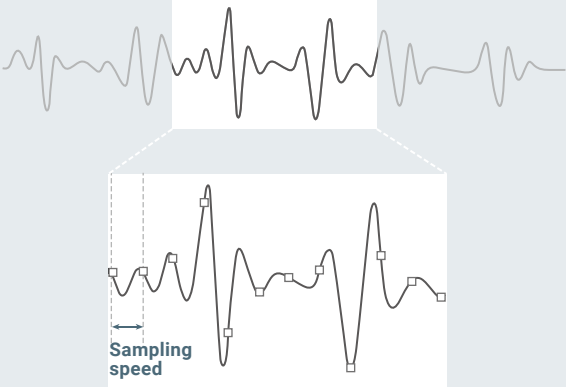

**Peak Data**

Peak data is sampling (■, ■, and □ points) between the designated recording speed at the fastest AD-conversion rate, and records two data points, the maximum value (■ points) and the minimum value (■ points). The amount of data can be compressed without losing the data singular point (peak value). Printer recording records data of this method on the chart paper.

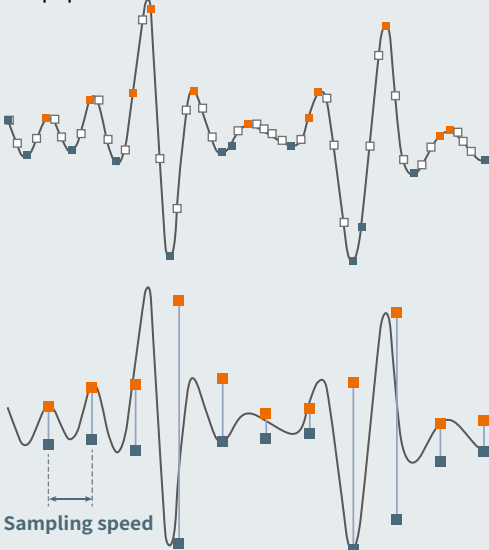

# Various Monitor Displays

Input signal and recorded data can be displayed as Y-T waveform display, X-Y display, and FFT.

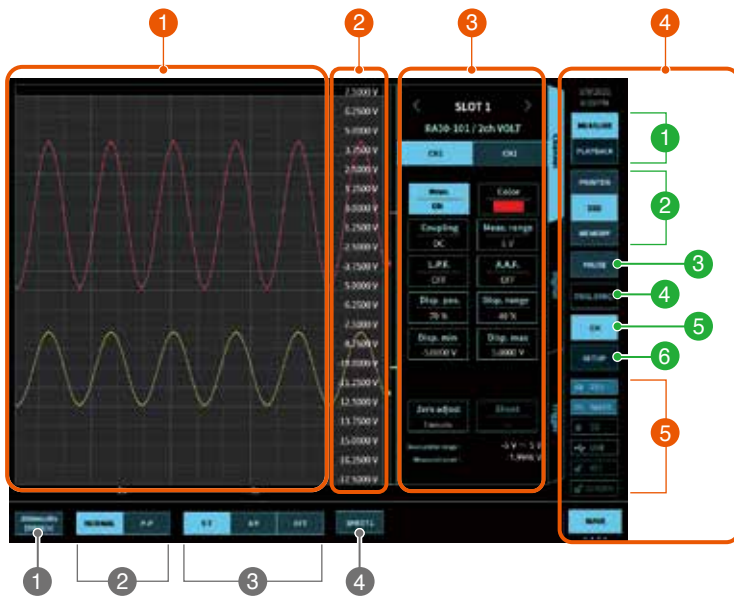

- 1 Waveform display Area**
- 2 Scale area**
- 3 Submenu**  
Press the [CH] key in the "Operation key area" to make settings related to the input module.
- 4 Side menu area**
- 5 Status display icon**  
Storage medium, interface, key lock
- 6 Chart speed switching**
- 1 Monitor selection**  
Measurement: Display the current input signal.  
Playback: Play back saved data
- 2 Monitoring device selection**
  - Data to printer
  - Data to SSD
  - Data to memory
- 3 Pause**  
Pause input monitoring
- 4 TRIG.SYNC.**  
Monitor synchronized with a trigger
- 5 CH**  
Input module settings
- 6 Settings**  
Measurement conditions setting screen
- 1 Data format of waveform display when recording to SSD**
- 2 Monitor waveform selection**  
Select Y-T waveform, X-Y waveform, or FFT analysis.
- 3 Sheet selection**

## Y-T Waveform Display

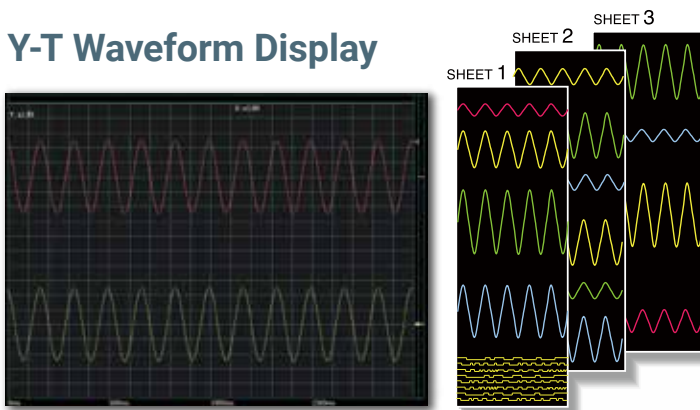

Display the measurement channels split into three sheets. Up to 48 channels of signals can be monitored on a sheet with 20 vertical/horizontal divisions. Graphs can be divided into 1 to 18 sheets and displayed.

## Set the signal display width and display position.

Signals can be drawn at any position on the graph at any width. You can easily draw a 100V signal in the width of 1 div.

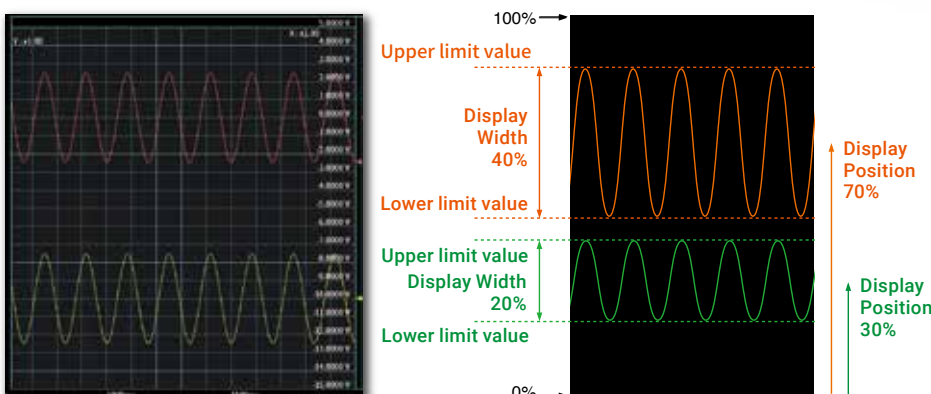

- Display Width**  
Display the signals of each channel at any width. Set the width of the channel to be displayed as % out of the 100% width of the display graph.
- Display Position**  
Set the position of the channel to be displayed as % out of the 100% width of the display graph.
- Scale Setting**  
Set the upper limit/lower limit value of display for the display width of each channel as an input value or a physical conversion value.

## X-Y waveform Display

An X-Y waveform can be drawn by specifying 4 channels for the X-axis and 4 channels for the Y-axis. The screen format can be displayed a large single screen format, or divided four screen formats for the each X and Y axis channels. The pen can also be moved up or down, and the grid can be turned on or off.

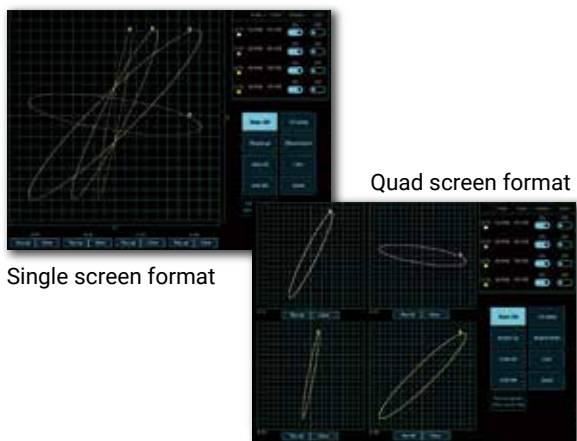

## FFT Analysis

FFT analysis is performed for any two signals. The top 10 highest values can be read from the analysis results, and the value of any analysis result can be read using the cursor. (FFT analysis can be performed on normal data recorded in SSD.)

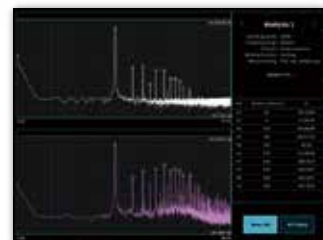

Data selection	Select from the input signal or recorded data
Sampling	1000, 2000, 5000, 10,000
Maximum analysis frequency	1/2 times of the sampling frequency
Display format	1 screen, 2 screens.
Functions	Time-Axis waveform, Linear Spectrum, RMS Spectrum, Power Spectrum, Power spectrum density, 1/1 Octave, 1/3 Octave, Transfer Function, Cross-Power Spectrum, Coherence Function
Window Functions	Hanning window, Hamming window, Rectangular window
Average processing	Time axis simple addition average, Frequency axis simple addition average, Frequency axis exponent weighted average, Frequency axis peak hold
X-axis scale	Time, Linear frequency, Log frequency, 1/1 octave, 1/3 octave
Y-axis scale	Real value area, Imaginary number area, Amplitude, Logarithmic amplitude, Auto scale or manual scale in accordance with the phase analysis results

## Recording Mode Selection

Nine measurement patterns are prepared as Recording modes.

"Recording Mode" can be selected from Measurement starts by manual operation, Measurement starts from a trigger signal or Repeating measurement, etc. When "Recording Mode" is selected, the necessary set-up menu is displayed and can be easily set.

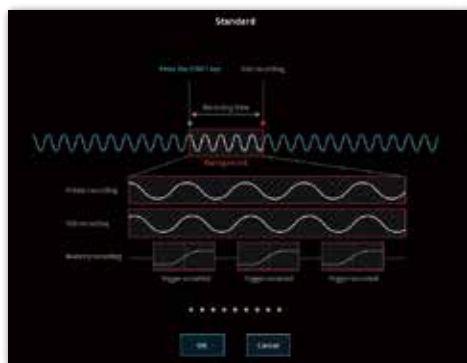

- |   |  |  |
|---|--|--|
| 1 Normal record                           | 2 Start time   | 3 Start trigger                        |
| 4 Interval time (N times)                 | 5 Start time + Start trigger                           | 6 Start time + Interval time (N times) |
| 7 Start trigger + Interval time (N times) | 8 Start time + Start trigger + Interval time (N times) | 9 Window recording                     |

## PC Compatibility

\*1 The software can be downloaded from our website:  
[https://www.aandd.co.jp/support/soft\\_download/industrial.html](https://www.aandd.co.jp/support/soft_download/industrial.html)

### Web server, FTP server

The RA3100 can be remotely operated from a web browser (operating PC). The web browser displays the same screen as the RA3100 main unit with pseudo operation panel keys (START key, etc.) to make settings and start/stop recording. Additionally, data stored on the LAN of the RA3100 can be transferred to a PC.

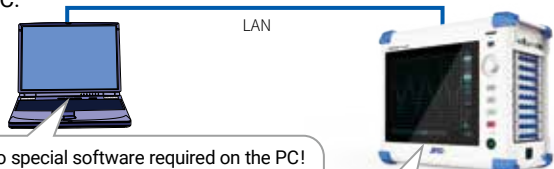

No special software required on the PC!  
 Access the RA3100 from a web browser.  
 Web browsers:  
 Microsoft Edge / Google Chrome

The RA3100 includes a web server and FTP server.

### Software for displaying measurement data\*1

"RA3100 Viewer" is software to display recorded data exported to external media from an RA3100 on a PC.

### PC software for converting measurement data\*1

The "File Converter" software can convert recorded data exported to external media from an RA3100 to CSV or ASAM MDF \*2 (Ver. 4.1) files on a PC.

\*2 ASAM : Association for Standardization of Automation and Measuring Systems  
 MDF : Measurement Data Format

# Various input modules

## Voltage input modules 5 types Lineup of input modules for measuring many voltage signals from small to high

Name	2ch Voltage Module	4ch Voltage Module	2ch High-speed Voltage Module	2ch High-Voltage Module
Model name	RA30-101	RA30-102 / RA30-113	RA30-103	RA30-107
Appearance				
Function	Input module capable of measuring $\pm 500V$ voltage. Anti-aliasing filter allow for frequency analysis with no wrap-around.	This is an input module that can measure voltage on 4 channels. Using 9 slots allows measurement of up to 36 channels. The RA30-102 can measure up to $\pm 200V$ , and the RA30-113 can measure up to $\pm 500V$ .	This input module is capable of high-speed sampling at 20MS/s and measurement of $\pm 500V$ input voltage.	This module can directly input high voltage of $\pm 1,000V$ (700Vrms). Voltage waveform or RMS value can be measured.
No. of channels	2ch	4ch	2ch	2ch
Maximum input voltage	Maximum input voltage: $\pm 500V$ 	Maximum input voltage $\pm 200V$ (RA30-102) / $\pm 500V$ (RA30-113) 	Maximum input voltage: $\pm 500V$ 	Maximum input voltage: $\pm 1,000V$ 
Range	500V to 0.1V	200V to 1V(RA30-102) / 500V to 2V(RA30-113)	500V to 0.1V	1,000V to 2V
Sampling speed				
A/D Resolution	16bit	16bit	14bit	16bit
Other function	With anti-aliasing filter	-	-	RMS conversion
Input cable	Insulated BNC cable (RA30-507) 	Insulated BNC cable (RA30-507) 	Insulated BNC cable (RA30-507) 	High voltage alligator clips(RA30-509-1) High-voltage connection cable (RA30-509-2) 

### 2ch AC Strain Module RA30-104

This input module enables stress measurement using strain gauges as well as strain gauge transducers such as load cells, pressure transducers, and torque transducers. The AC bridge method can be used for measurement that is strong against external noise.

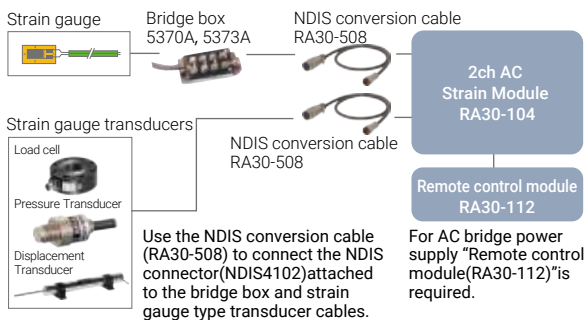

### 2ch Acceleration Module RA30-109

This module can measure acceleration, speed, and displacement of mechanical vibration using a piezoelectric acceleration transducer (built-in amplifier, charge output type). For mathematical functions, RMS conversion, and then envelope processing can be performed.



### 2ch Temperature Module RA30-106

An input module for a thermocouple or resistance temperature detector. Thermocouples can be used for high temperatures and wide temperature ranges, while resistance thermometers can be used to measure temperatures near room temperature with high accuracy.

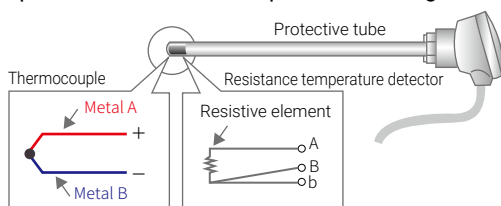

#### Features of Thermocouples and Resistance Temperature Detectors

Thermocouple	Advantages	Disadvantages
A sensor utilizing the phenomenon that a voltage is generated when a temperature difference is applied to the contact points at both ends of a circuit created by connecting two different types of metal wires.	Low cost, high temperature and wide temperature range (-200 to 2,300°C), small temperature measurement objects, measurement in confined spaces, fast thermal response	Poor accuracy (compared to Resistance temperature detector), reference junction required
Resistance temperature detector	Advantages	Disadvantages
A sensor utilizing the phenomenon that the electrical resistance of metals changes with changes in temperature.	High accuracy (compared to Thermocouple), no reference junction required	Large form factor, slow response, narrower temperature range (-200 to 850°C) than thermocouple, expensive, weak against vibration and shock

### Envelope processing

Envelope processing helps to identify abnormal areas of bearings (inner rings, outer rings, and rollers/balls) by looking at the periodicity of vibrations caused by bearing flaws.

Envelope-processed signals are subjected to frequency analysis and the resulting primary frequency and information such as the size of each bearing part, the number of rollers and balls, and the shaft rotation speed can be used to infer the damaged part.

#### Envelope processing depiction

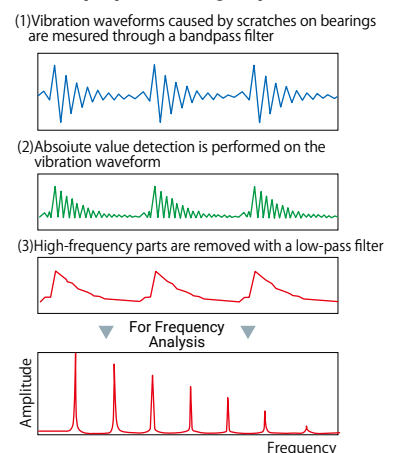

## 2ch Frequency Module RA30-108

Period, rotation speed, pulse count, etc. can be measured for the input pulse signal.  
Measurement result data such as period, rotation speed, pulse count, etc., and the input pulse signal can be saved.

### Measurement Mode

#### ● Period

Measures the period of the measured pulse. (s: seconds)  
Measures the width (Tb) from leading edge to leading edge of the pulse.

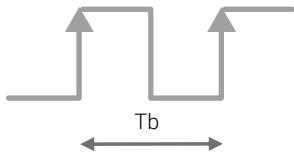

#### ● Pulse Width Mode

Measures the pulse width (Tp) from leading edge (trailing edge) to trailing edge (leading edge) of the pulse. (s: seconds)

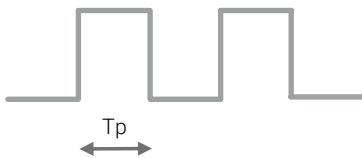

#### ● Rotation Speed Mode

Measure the rotation speed of the measured pulse. (rpm: rotations) Rotation speed (rpm) = 60 / (Measured period x No. of pulses per revolution)

\* The number of pulses per revolution can be set from 1 to 100.



The gear to the left has 11 teeth, so the number of pulses per revolution is 11.

#### ● Range of Variation Mode

Measures the variation from the measured frequency and the set center frequency. (%)

Range of variation (%) = Measurement frequency / Center frequency

The illustration below shows the range of variation from frequency analysis data.

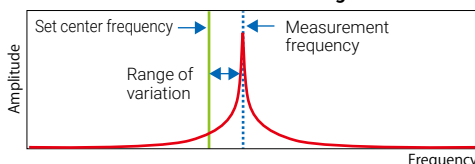

This module detects the frequency from the input pulse and calculates the variation from the set center frequency value. Changes in range of variation can be measured as sequential data.

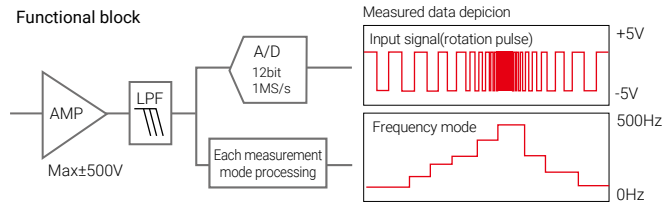

#### ● Frequency Mode

Measure the frequency of the measured pulse. (Hz: hertz)  
Calculates the period from the width (Tb) from leading edge to leading edge of the pulse.

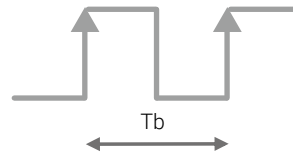

#### ● Duty Ratio Mode

Measures the pulse ratio (Ta/Tb) from leading edge (trailing edge) to trailing edge (leading edge) of the pulse. (%)

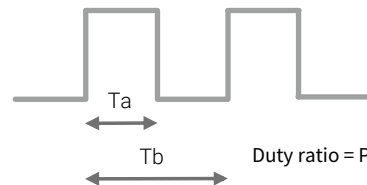

#### ● Power Frequency Mode

Measures fluctuations in power supply frequency (50/60/400Hz).

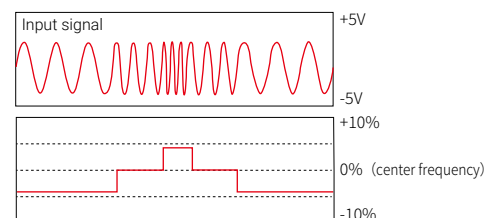
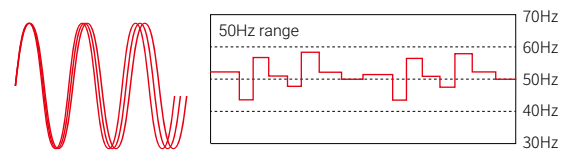

## ● Pulse Count Mode

Integrates the number of pulses confirmed from pulse leading edge (trailing edge) to trailing edge (leading edge) within the gate time. The count value is cleared at every gate time.

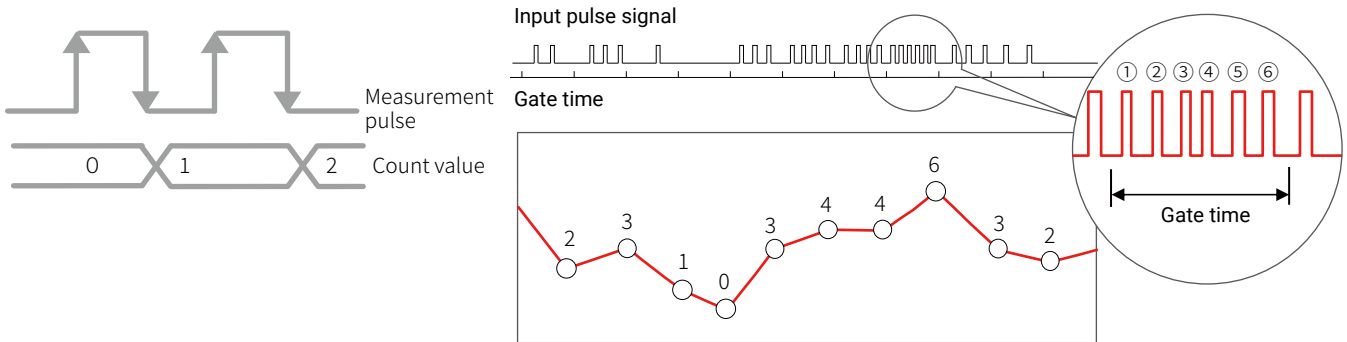

The number of pulse signals input within the gate time is counted and recorded.

- Maximum integration: Up to 40,000 counts can be counted.  
(Minimum pulse width: 2.5 $\mu$ s)

## ● Pulse Integration Mode

Integrates the number of pulses when the pulse is confirmed from leading edge (trailing edge) to trailing edge (leading edge) of the pulse.

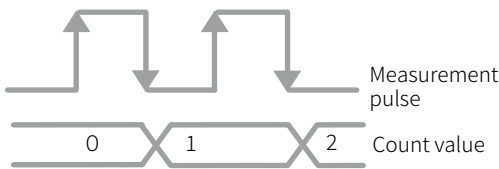

### Count value reset operations

**OFF** : Count value is stopped at the range upper limit.

**Start** : When recording starts, the count value is reset and then stopped at the range upper limit.

**Over** : When the count value reaches the upper limit of the range, the count value is reset and measurement starts again from 0.

**Start & Over** : The count value is reset when recording starts. When the count value reaches the upper limit of the range, the count value is reset and measurement starts again from 0.

Reset operation : OFF

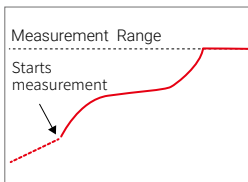

Reset operation : Start

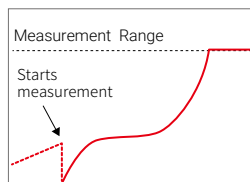

Reset operation : Over

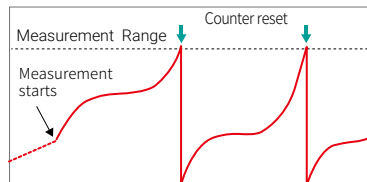

Reset operation : Start & Over

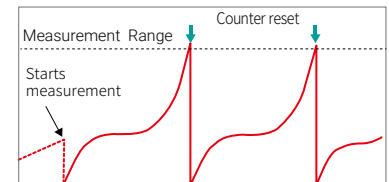

## 16ch Logic Module RA30-105

One unit of this input module can input 16 channels of logic signals and when 9 modules are installed in the main unit, 144 channels of logic signals can be measured. Detects and records high and low voltage (0 to 24V) or open and closed contacts. Furthermore, by connecting probes, it is possible to measure high and low AC and DC voltages up to 250V and power line variations (100V and 200V).

Single cable/ adapter	8ch logic cable (alligator, IC clip) RA30-501, RA30-502 	Floating voltage probe 1539S+ 8ch logic cable (round type convertor connector) RA30-503 	Voltage conversion probes for recording voltage increases and decreases 1540S/1543S+ 8ch logic cable (round type convertor connector) RA30-503 
Function	Records high and low voltage (0 to 24V) or open and closed contacts. DC24V, closed 0V, open 	High and low AC/DC voltages of up to 250V can be measured. DC250V DC80V DC18V H L Output 	Power line fluctuations (100V, 200V) can be measured. Commercial power line fluctuation ch1 ch2 

# High-speed, high-definition recording

High-speed (100mm/s) and high-definition (80dots/mm at 25mm/s) recording is possible. The maximum number of signals that can be recorded simultaneously is 48.

In addition to signals, the recording name, measurement start time, trigger mark, recording speed, etc., can be printed. You can freely change the number of graphs to record, the width of each graph (2.5mm to 215mm), and the space between graphs. In addition, the position and amplitude of the event signal can be changed every 8 channels.

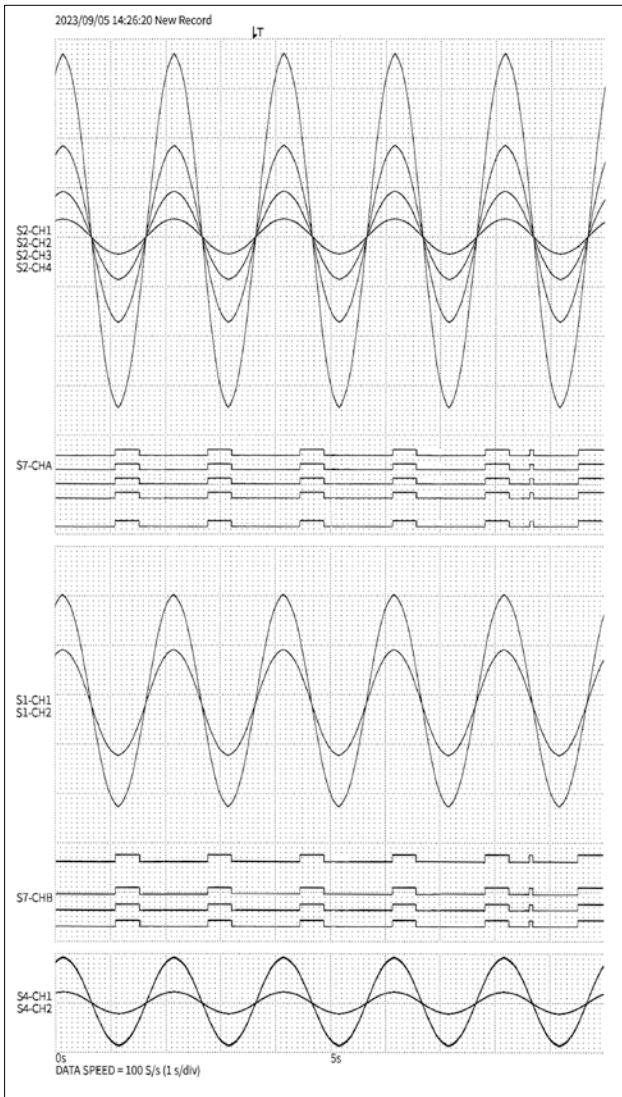

## Auto scale

The scale can be printed after recording.

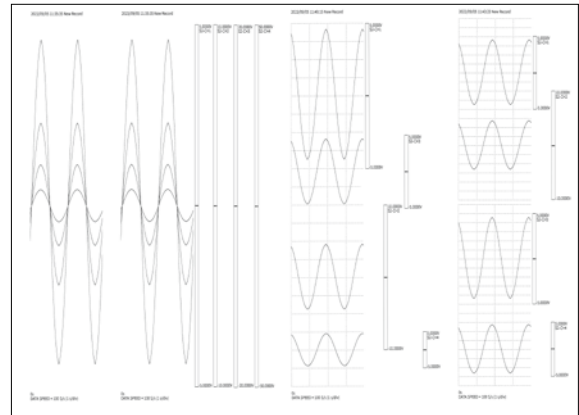

## Recording division

Records can be divided from 1 to 18.

Recording width can be adjusted from 215mm to 2.5mm.

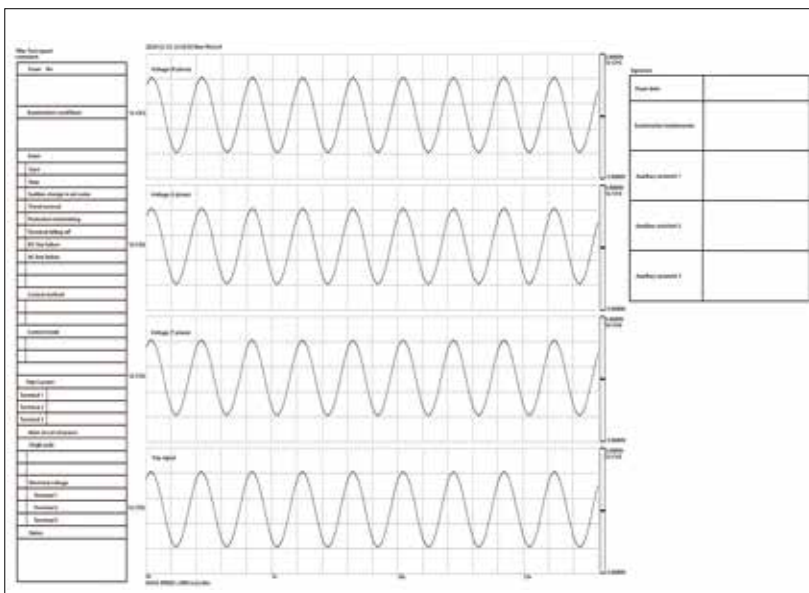
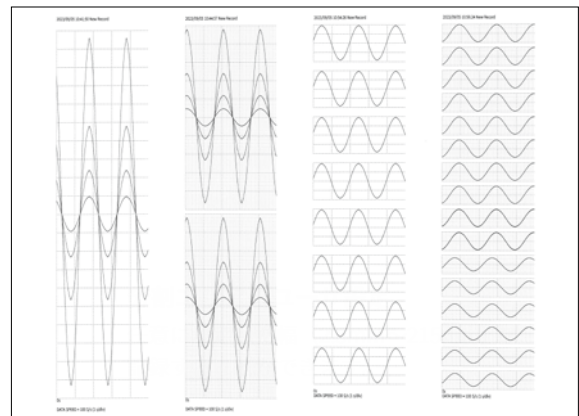

## Headers / Annotations / Footers

When recording waveforms to the printer, an arbitrary character string can be printed before (header), during (annotation), and after (footer) the waveform recording.

# Input Module and Peripheral Option Selection Guide

Input Signal		Probes and Cables	
Voltage	±1,000V (DC or ACpeak)	<b>Alligator clip for High Voltage RA30-509-01</b> <b>Connection cable for High Voltage RA30-509-02</b> <b>Extension cable for High Voltage RA30-509-03</b>	
	±500V (DC or ACpeak)	<b>Isolated BNC cable (Alligator clip) RA30-507</b>	
Current	High current	<b>AC/DC clamp meter 2009R (Kyoritsu)</b> • 2,000A, 400A • DC, 20 to 1kHz • φ55	
	Medium current Low current	<b>Clamp Sensor 8115 (Kyoritsu)</b> • 130A AC, 180A DC • DC, 40 to 1kHz • φ12	<b>BNC-Safety jack adapter 0243-3021</b> 
		<b>Clamp Adaptor 8112 (Kyoritsu)</b> • 20A, 2A, 0.2A • 40 to 10kHz • φ8	
Voltage fluctuation	±10% and ±20% of 100V type or 200V type	<b>AC Voltage Level Detector 1540S/1543S</b> This unit detects voltage fluctuations of power line. ±10% and ±20% of 100VAC or 200VAC lines can be detected	
Voltage detection	50VAC to 250VAC 20V to 250VDC	<b>AC/DC Voltage Detector 1539S</b> This unit detects AC or DC voltage and outputs as High/Low. It supports 4 channels 50 to 150V AC: Low 100 to 250V AC: High 20 to 150V DC: Low 80 to 250V DC: High	

**8ch Logic input cable (round type connector converter) RA30-503**

Input Signal		Probes and Cables	
Logic	At voltage input, contact input	<b>8ch Logic cable (IC clip) RA30-501</b>	<b>8ch Logic cable (Alligator clip) RA30-502</b> 
		<b>Remote control input cable (loose wire) RA30-506</b>	
		<b>MDR20 Pole terminal block AX-PCX-10S20</b>	<b>Terminal block connection cable RA30-504</b>

Input Signal		Probes and Cables	
Pulse	±500V (DC or ACpeak)	<b>Pulse encoder</b>	

Input Signal		Probes and Cables	
Temperature	Thermocouple K,E,J,T,N,R,S,B,C RTD Pt100, Pt1000	<b>Covered and sheathed thermocouples</b>	<b>Temperature sensor connection connector RA30-555</b>

Input Signal		Probes and Cables	
Vibration (impact acceleration)		<b>Amp-embedded charge accelerometer SV2000 series</b>	
		<b>Piezoelectric accelerometer SV1000, 9Fseries</b>	
		<b>Charge converter</b> This unit is necessary when piezoelectric accelerometers are used. AP11-901 AP11-902 AP11-903	

Input Signal		Probes and Cables	
Strain, load, displacement, acceleration, and torque		<b>Strain gauge</b>	<b>Bridge box 5370A, 5373A</b>
		<b>Strain gauge sensors</b> : Load cell, Pressure transducer, Displacement transducer, Torque transducer, Slip ring and Accelerometer	

**NDIS Conversion cable RA30-508** Transducer side: Jack to RA30-104 side: Plug

Input Module	
<b>2ch Voltage module RA30-101</b> Input module to measure voltage with anti-aliasing filters • ±100mV to ±500V • 1MS/s (1μs) • A/D : 16bit	
<b>4ch Voltage module RA30-102</b> Input module to measure multi-channel voltage • ±1V to ±200V • 1MS/s (1μs) • A/D : 16bit	
<b>4ch Voltage module RA30-113</b> Input module to measure multi-channel voltage • ±2V to ±500V • 1MS/s (1μs) • A/D : 16bit	
<b>2ch High-speed voltage module RA30-103</b> Input module to measure high-speed voltage • ±100mV to ±500V • 20MS/s (50ns) • A/D : 14bit	
<b>2ch High Voltage Module RA30-107</b> Input module to measure 1,000V range • ±2V to ±1,000V • 1MS/s (1μs) • A/D : 16bit	
<b>16ch Logic module RA30-105</b> Input module that records voltage (H, L) or contact (open, close) • Number of input: 16ch • 1MS/s (1μs) • Input : Voltage or contact	
<b>2ch Frequency Module RA30-108</b> Period, rotation speed, pulse count, etc. can be measured. • ±1V to ±500V • 1MS/s (1μs) • A/D : 12bit	
<b>2ch Temperature module RA30-106</b> Input module to measure temperature with a thermocouple and RTD • Thermocouple (K,E,J,T,N,R,S,B,C) • RTD (Pt100, Pt1000) • Update rate: 1.5ms, 100ms, 1s • A/D : 16bit	
<b>2ch Acceleration Module RA30-109</b> This module can measure acceleration, speed and displacement. • Piezoelectric acceleration transducer input • 1MS/s (1μs) • A/D : 16bit	
<b>2ch AC Strain Module RA30-104</b> Input module for high-sensitivity strain measurement. • 500 x 10 <sup>-6</sup> Strain (BV=2V) • 100kS/s (10μs) • A/D : 16bit *For AC bridge power supply "Remote control module (RA30-112)" is required.	

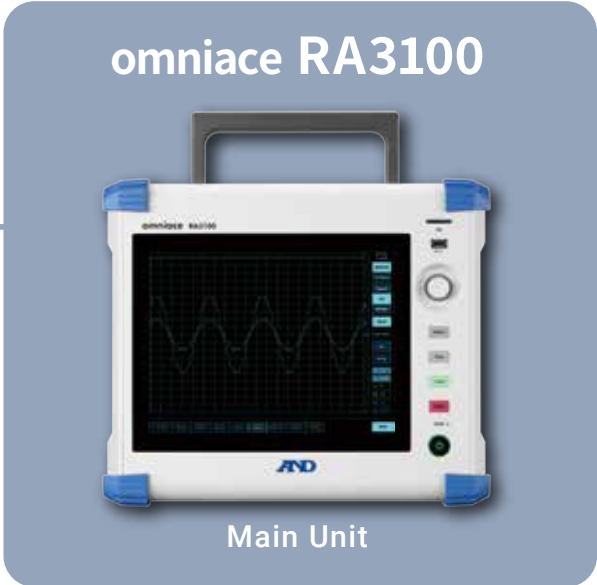

Main Unit

**Control Module**

**Remote control module RA30-112**

Start/stop, mark printing, paper feed, external sampling by external signal, external trigger signal input and trigger signal output, Bridge power supply to 2ch AC strain module



**Control Cable**

**Remote control cable (among main units) RA30-505**



**Remote control input cable (loose wire) RA30-506**



**MDR20 Pole terminal block AX-PCX-10S20**



**Terminal block connection cable RA30-504**



**External Storage Medium**

**SD Memory card (4GB) RM11-453**  
**SD Memory card (8GB) RM11-454**

**Z-fold Paper Storage Box**

**Z-fold Paper Storage Box RA30-551**  
 Including Z-fold paper adaptor RA12-301



Dimensions: H97 x W283 x D371 (mm)  
 Weight: 4kg or lower

**Z-fold paper adaptor RA12-301**



**Recording Paper**

**Recording Paper YPS106**  
 219.5mm x 30m roll paper (5 rolls/box)



**Recording Paper (with perforated line) YPS108**  
 219.5mm x 30m roll paper (5 rolls/box)



**Recording Paper (Z-fold paper) YPS112**  
 219.5mm x 201m Z-fold paper (1 set/box)



**Other**

**Soft Carrying Case RA23-183**



**Hard Carrying Case with Casters RA30-552**



Dimensions: H635 x W450 x D320(mm)  
 H550 x W450 x D320(mm): Castor wheels not included  
 Weight: 8.5kg or lower

# Basic Specifications

Specifications			
Recording Function	Memory Recording	High speed event recording to memory	*Any combination of memory recording, SSD recording, and printer recording is possible.
	SSD Recording	Recording of the input signal to the internal SSD	
	Printer Recording	Thermal printing using a thermal head	
Channel	Module Slot	9 slots	
	Analog Measurement	Max 36 channels (when 9 pcs 4-channel voltage modules are installed)	
	Logic Measurement	Max 144 channels (when 9 pcs 16-channel logic modules are installed)	
Sampling Speed	Memory Recording	20MS/s(50ns) to 10S/min	
	SSD Recording	1MS/s(1μs) to 10S/min	
	Printer Recording	1KS/s(100mm/s) to 10S/min(1mm/min)	
Memory Capacity	4GB(2G points/ch)		
Storage Device	Solid State Drive (SSD) 256GB		
	SD card (supporting SD / SDHC / SDXC) for data storage after recording.		
	USB memory using a USB port, for data storage after recording.		
Printer	Printing Method	Thermal printing using a thermal head	
	Paper Width	219.5mm	
	Effective Recording Width	Maximum 215mm	
	Chart Speed	100mm/s to 1mm/min	
Trigger	Uses	Trigger for starting record operations (Start Trigger), trigger for memory recording (Memory Trigger).	
	Start Trigger	Trigger to start recording operation (selected by manual trigger, external trigger, or measuring channel (arbitrary 1ch))	
	Memory Trigger	Trigger to start memory recording (selected by manual trigger, external trigger, or measuring channel (arbitrary 1ch))	
	Trigger Source	Input signal (analog/logic), manual trigger, external trigger	
	Trigger type	Level trigger, window trigger (memory recording trigger), bit pattern trigger	
	Trigger Mode	Set AND/OR for the measuring channel.	
	Pre-trigger	0 to 99% (1% step)	
	Trigger Mark	The trigger point is indicated with a "T" mark, and the trigger date and hour/minute/second are printed.	
	Trigger Filter	Filter duration: 0 to 100 seconds	
	External Trigger Input	External signal input (Active Low, High level: 2.1V to 5.0V, Low level: 0V to 0.5V, Pulse width: at High-speed response: 1μs or higher at high level, 1μs or higher at low level / at Normal response: 1ms or higher at high level, 1ms or higher at low level / at Low response: 10ms or higher at high level, 10ms or higher at low level)	
	Trigger Output	Output signal when trigger conditions are met (Active Low, H: 3.8V or higher, L: 0.5V or less, Pulse width: 1μs at high speed response, 1ms at normal response, 10ms at low-speed response)	
Monitor	Y-T Waveform Monitor	Display amplitude waveform of measuring signal during time changes.	
	X-Y Waveform Monitor	Input signal 1 is plotted in the X axis and input signal 2 is plotted in the Y axis to display correlation of those signals.	
	FFT Analysis Monitor	FFT analysis of the measuring signals of any two channels is performed, and the analysis results are displayed in the frequency axis.	
Display	12.1-inch XGA TFT color LCD (1024 x 768 pixels) with capacitive touch panel		
Operation Section	Operation Panel Key	POWER ...	Power ON/OFF
		START ...	Start of measurement
Interface	Rotary Knob	Change of the measuring range, waveform position, etc.	
	LAN	100BASE-T (1Gbps) ... For control by communication command	
	COM	RS-232C ... For control by communication command	
	USB	Ver. 3.0 2 port ... For storage devices (USB memory)	
	SD Card	SD standard (SD/SDHC/SDXC supported)	
	Video Output	DVI-D ... Digital output for external display	
Compliance Standards	Safety	EN 61010-1, EN 61010-2-30 Overvoltage category (installation category) II Measurement category : Depends on the specifications of each input module.	
	EMC	EN61326-1 ClassA	
Operating Environment	Temperature	0 to 40°C	
Storage Environment	Humidity	35 to 85 %RH (without condensation)	
	Temperature	-20 to 60°C	
Vibration Resistance	Humidity	20 to 85%RH (without condensation)	
	Random Vibration Durability Test	Frequency : 5 to 500Hz, Acceleration : 6.5m/s <sup>2</sup> on X-axis and Y-axis, 10.2m/s <sup>2</sup> on Z-axis	
Backup Battery Life (for Clock Backup)	Sine Wave Vibration Durability Test	Frequency : 10 to 55Hz, Acceleratin : 20.0m/s <sup>2</sup> , 20 cycles for each of the three axes	
	Approx. 10 years (at the surrounding temperature is 23 °C)		
Power Consumption	Power-supply voltage	100 to 240V AC, frequency 50/60Hz	
	Power Consumption	300VA or less (under the maximum load conditions), 80VA when recording is stopped, 5VA during stand-by	
Dimensions	394(W)× 334(H)× 199(D)mm *excluding projections		
Weight	9.5kg or less (main body only),		

Recording Function Specifications		
Memory Recording	Function	After data is recorded to the internal memory at the set sampling rate, the data is automatically saved to the SSD.
	Memory Capacity	4GB (2G points/ch)
	Data Type	Normal data, Can be saved to a CSV file (trigger criteria 1 to 100%)
	Memory Division	1 to 200 Div. (The maximum value changes depending on the channel used and recording length)
	Number of data	2,000 to 2G point/ch (1-2-5 step : The maximum value changes depending on the channels and division number used)
	Sampling Speed	20MS/s (50ns) to 10S/min, Max. 18ch for 20MS/s when simultaneous measurement
SSD Recording	Maximum Recording time	100days
	Recording Operation	by START/STOP button for Time recording, Interval recording, and START trigger recording
	Function	The measurement data of the input signal is directly recorded to the internal SSD.
	Data Logging Capacity	Internal SSD (256GB)
	Data type	Normal data and peak data selectable
	Sampling Speed	1MS/s (1μs) to 10S/min, Max. 500kS/s in case of peak data
Printer Recording (Pen-Recording)	External Synchronization Sampling	Synchronous clock: 250kHz or less *Recording by external synchronization can be either SSD recording or printer recording (Pen Record recording).
	Maximum Recording Time	100days
	Recording Operation	by START/STOP button for Time recording, Interval recording, START trigger recording, window recording
	Window Recording	The data is recorded in the ring buffer area (max. 2G point/ch) specified as the window recording time. When the data is exceeded the data area, overwrite from the top of the data area and record all data up to the end of measurement. SSD recording can not be used with memory recording and printer recording at the same time. The data format is normal data.
	Function	Outputs the input signal directly to the printer.
	Paper Width	219.5mm
Printer Recording (Pen-Recording)	Effective Recording Width	Maximum 215mm
	Recording Operation	by START/STOP button for Time recording, Interval recording, START trigger recording : Waveform recording on the chart paper while saving the data to the SSD. Playback and copy is possible after recording. by PRINT button(Pen-Recording): Direct waveform recording to chart paper without saving any data. Chart speed and measuring range can be changed during recording.
	Number of Recording Channels	Max. 48 channels per sheet, Measuring channels can be divided in 3 sheets.
	Data Type	Peak data (at Printer Recording)
	Chart Speed	100mm/s (1kS/s) to 1mm/min (10S/min), User Default Setting enabled. Max. 50mm/s (500Hz) at external synchronization *Recording by external synchronization can be either SSD recording or printer recording (Pen Record recording).
	Printing Density	Amplitude axis : 8dots/mm Time axis : 80dots/mm (at 20mm/s), 40dots/mm (at 50mm/s), 20dots/mm (at 100mm/s) 40dots/mm (at external synchronization)
Monitor Specifications (on recording and replay)		
Y-T Waveform	Recording Function	Displays during memory recording, SSD recording, and printer recording
	Supported Data Type	Normal data, Peak data
	Number of Sheets (Screen)	Max. 48 channels per sheet (screen), Measuring channels can be divided in 3 sheets (screen).
	Number of Graphs	1 to 18 (The height of each graph on the recording paper can be changed in increments of 2.5mm.)
	Grid Count	Vertical : 20div., Horizontal: 20div. (when 1 graph is displayed on screen)
	Time Axis Data Count	100data/div
	Display Function	Numeric display, Signal Name, Amplitude Axis Scale, Recording Time, Trigger Mark, Cursor, Thumbnail
	Display Width	The signal of each channel is displayed at an arbitrary width (Set by % as the full display graph width is 100%)
	Display Position	Display the signal of each channel at any position (Set by % as the full display graph width is 100%)
	Scale Setting	Set the upper limit/lower limit values as input values or physical conversion values for each display width.
	Logic Waveform Display	16ch logic waveform display position movable
X-Y Waveform	Recording Function	Displays during SSD recording
	Supported Data Type	Normal data
	Sampling Rate	1KS/s or less
	Display format	1 screen (up to 4 concurrent waveforms), 4 screens (1 waveform per graph)
	Grid Count	Vertical : 20div., Horizontal : 20div.
	Display Function	Draw X-Y waveform with dots or lines in X-axis/Y-axis scale, pen up/down setting available.
	Scale Setting	Set the max/min scale values as input values or physical conversion values for each graph.
	Locas	ON/OFF of locas enabled (pen up & down)
	Printing	Print the plotted X-Y waveform with the printer
	Recording Function	Display during SSD recording
	Supported Data Type	Normal data
Sampling Points	1,000, 2,000, 5,000, or 10,000points	
Sampling Speed	1MS/s or less	
Max Analysis Frequency	1/2 times of the sampling frequency	
Display format	1 screen, 2 screens.	
FFT Analysis	Function	Time axis waveform, Linear spectrum, RMS spectrum, Power spectrum, Power spectrum density, 1/1 octave analysis, 1/3 octave analysis, Cross power spectrum, Transfer function, Coherence
	Window Function	Hanning, Hamming, Rectangular
	Average Processing	Time axis simple addition average, Frequency axis simple addition average, Frequency axis exponentially weighted average, Frequency axis peak hold or off
	Number of Averaging	1 to 10
	X-axis Scale	Time, Linear Frequency, Log Frequency, 1/1 Octave, 1/3 Octave
	Y-axis Scale	Real value area, Imaginary number area, Amplitude, Logarithmic amplitude, Phase Auto scale or manual scale in accordance with the analysis results
Peak Value Display	Extract the local maximum value or a maximum value of 10 points from the analysis result.	

# Remote Control Module Specifications

Other Specifications		
<b>Recording Mode</b>	There are nine selectable measurement modes. Normal recording/Start time/START trigger/Interval time (N times)/Start time + START trigger/Start time + Interval time (N times)/START trigger + Interval time (N times)/Start time + Interval time (N times)/Window recording	
<b>Playback Processing</b>	<b>Scaling</b>	The display position can be changed with pinch-in, pinch-out scaling, zooming, and swiping.
	<b>Cursor</b>	Y-T: Measured value at the cursor position Time display between cursors, Max/Min value/Average value FFT: Cursor position frequency and pulse amplitude
	<b>Back Scrolling</b>	Measured data can be monitored while recording by pressing the [PAUSE] button.
<b>Printer Section</b>	<b>System Annotations</b>	Measurement start time, Recording name, Trigger condition (Trigger point, Trigger date, Trigger time) Sampling speed, Chart speed, Time axis, etc. are printed at the same time as waveform recording
	<b>Mark Print</b>	Printing marks (date/time) on the chart paper or the data on SSD
	<b>Header, Footer, and Page Annotations</b>	Any character can be printed before, during, or after the waveform area during printing (Up to 60 characters horizontally and 86 lines vertically)
	<b>Screen Copy</b>	Print screen image on chart paper
<b>Screen Image Saving</b>	Save screenshots in PNG format (color) on the main unit or on a storage medium	
<b>Save/Readout of Settings</b>	Save settings (input and main unit setting conditions) on SSD Measuring conditions saved in the SSD can be read out.	
<b>Keylock Function</b>	· Lock operation panel keys · Lock the touch panel	
<b>Monitor Brightness</b>	Adjustable	
<b>Physical Value Conversion</b>	Physical conversion of input signals, Change of full scale on display, Registration of units.	
<b>Language</b>	Japanese, English, Chinese (simplified, combined), Korean	

Remote Control Module RA30-112 Specifications	
<b>Input Connector</b>	half-pitch 20-pin connector
<b>Output Connector</b>	half-pitch 14-pin connector
<b>External Input</b>	Function: Control by external signal.
<b>Control Signal</b>	START/STOP, MARK, FEED, PRINT, TRIG
<b>Input Level</b>	High level: 2.1V to 5.0V, Low level: 0V to 0.5V (active low)
<b>Response Speed</b>	Select from High-speed/Normal/Low-speed
<b>Effective Pulse Width</b>	High-speed response: 1μs or higher during high interval, 1μs or higher during low interval
	Normal response: High interval 1ms or higher, Low interval 1ms or higher Low-speed response: 10ms or higher during high, 10ms or higher during low-speed response
<b>Max. allowable Input Voltage</b>	30V
<b>External Output</b>	Function: Control signals can be externally output
<b>Control Signal</b>	START/STOP, MARK, FEED, PRINT, TRIG, EXT1/EXT2
<b>Output Level</b>	High level: 3.8V to 5.0V, Low level: 0V to 0.5V (active low)
<b>Output Pulse Width</b>	START/STOP, FEED, PRINT: Active output during operation TRIG, MARK: High-speed response: 1μs/Normal response: 1ms/ Low-speed response: 10ms
<b>External Sampling Input (EXT.SAMPL IN)</b>	Synchronization via external clock signal is possible (simultaneous SSD recording and printer recording are not possible.)
<b>Input Level</b>	High level: 2.1V to 5.0V, Low level: 0V to 0.5V
<b>Effective Pulse Width</b>	High-speed (SSD Recording): 2μs or higher/Low-speed (Printer Recording): 1ms or higher
<b>Maximum Input Frequency</b>	High-speed (SSD Recording): 250kHz/Low-speed (printer recording): 500Hz, 0.1mm/pulse
<b>External Sampling Output (EXT.SAMPL OUT)</b>	Function: Synchronization clock signal can be output externally
<b>Output Level</b>	High level: 3.8V to 5.0V, Low level: 0V to 0.5V (active low)
<b>Synchronization Signal for AC Strain Input/Output</b>	Function: Synchronization signal generator for using AC strain
<b>Carrier Wave</b>	0V to 5V, square wave, 5kHz
<b>Synchronization</b>	Synchronization possible with other RA3100 including RA30-112
<b>Reference Clock for Calibration</b>	Function: Square wave signal output for operation check of voltage input module
<b>Output Level</b>	0V to 5V (±1%)
<b>Output Frequency</b>	1kHz (±1%)
<b>Duty Ratio</b>	50% (±5%)
<b>Withstand voltage</b>	AC300V, 1 minute (between input/output and main chassis)
<b>Maximum Rated Voltage to Ground</b>	AC, DC42V
<b>Dimensions</b>	Approx. 140 (input-side W) x 223(D) x 20(H) mm
<b>Weight</b>	Approx. 250g
<b>Compliance Standards</b>	Safety: EN61010-1 EMC: EN61326-1, class A

**External Drawing**  
RA3100



Unit: mm



# Input Module Specifications

2ch Voltage Module RA30-101	
<b>Input Channels</b>	2ch
<b>Input Connector</b>	Isolated BNC connector
<b>Input Type</b>	Isolated unbalanced input (Isolation between each channel, between each channel and main chassis)
<b>Input Coupling</b>	AC, DC, and GND coupling
<b>Input Impedance</b>	1MΩ
<b>Measurement Range (RANGE)</b>	±100, 200, 500mV, 1, 2, 5, 10, 20, 50, 100, 200, 500V
<b>Measurement Accuracy</b>	±0.3% of range (23°C±5°C, DC coupling, LPF 3Hz, after zero offset)
<b>Temperature Coefficient</b>	± (400ppm of range)/°C
<b>Frequency Response</b>	DC coupling : DC to 100kHz(-3dB to +1dB)(with LPF, AAF OFF) AC coupling : 0.3Hz to 100kHz(-3dB to +1dB)(with LPF, AAF OFF)
<b>Low-pass Filter(LPF)</b>	Cutoff frequency : 3Hz, 30Hz, 300Hz, 3kHz, OFF (-1.6dB±1dB) Characteristics : 2 pole Bessel type
<b>Anti-aliasing Filter(AAF)</b>	Cutoff frequency : 20, 40, 80, 200, 400, 800, 2k, 4k, 8k, 20k, 40kHz, OFF Attenuation : -66dB or less at 1.5 times of cutoff frequency
<b>A/D Converter</b>	A/D resolution : 16bit Sampling rate : 1MS/s (max)
<b>Allowable Input Voltage</b>	±500V peak
<b>Maximum Rated Voltage To Ground</b>	300V AC/DC CATII (between channels, between input terminals and chassis)
<b>Withstand Voltage</b>	3kV AC, 1 minute (between input terminal and main chassis, between each channel)
<b>Dimensions</b>	Approx. 140 (input-side W) x 223(D) x 20(H) mm
<b>Weight</b>	Approx. 300g
<b>Compliance Standards</b>	Safety : EN61010-1, EN61010-2-30 EMC : EN61326-1, class A

4ch Voltage Module RA30-102, RA30-113	
<b>Input Channels</b>	4ch
<b>Input Connector</b>	isolated BNC connector
<b>Input Type</b>	Isolated unbalanced input (Isolation between each channel, between each channel and the main chassis)
<b>Input Coupling</b>	DC and GND coupling
<b>Input Impedance</b>	1MΩ or higher
<b>Measurement Range (RANGE)</b>	RA30-102 : 1, 2, 5, 10, 20, 50, 100, 200V RA30-113 : 2, 5, 10, 20, 50, 100, 200, 500V
<b>Measurement Accuracy</b>	±0.2% of RANGE (23°C ±5°C, DC coupling, LPF 3Hz, after zero offset)
<b>Temperature Coefficient</b>	±(400ppm of range)/°C
<b>Frequency Response</b>	DC coupling : DC to 100kHz(-3dB to +1dB)(with LPF OFF)
<b>Low-pass Filter(LPF)</b>	Cutoff frequency : 3Hz, 30Hz, 300Hz, 3kHz, OFF (-1.6dB±1dB) Characteristics : 2 pole Bessel type
<b>A/D Converter</b>	A/D resolution : 16bit Sampling rate : 1MS/s (max)
<b>Allowable Input Voltage</b>	RA30-102 : ±200V peak / RA30-113 : ±500V peak
<b>Maximum Rated Voltage To Ground</b>	300V AC/DC CATII (between channels, between input terminals and chassis)
<b>Withstand Voltage</b>	3kV AC, 1 minute (between channels or between input terminals and chassis)
<b>Dimensions</b>	Approx. 140 (input-side W) x 223(D) x 20(H) mm
<b>Weight</b>	Approx. 320g
<b>Compliance Standards</b>	Safety : EN61010-1, EN61010-2-30 EMC : EN61326-1, class A

2ch High Speed Voltage Module RA30-103	
<b>Input Channels</b>	2ch
<b>Input Connector</b>	Isolated BNC connector
<b>Input Type</b>	Isolated unbalanced input (Isolation: between channels, between each channel and chassis)
<b>Input Coupling</b>	AC, DC, and GND coupling
<b>Input Impedance</b>	1MΩ or higher
<b>Measurement Range (RANGE)</b>	±100, 200, 500mV, 1, 2, 5, 10, 20, 50, 100, 200, 500V
<b>Measurement Accuracy</b>	± 0.5% of RANGE (23°C ±5°C, DC coupling, LPF 5Hz, after zero offset)
<b>Temperature Coefficient</b>	± (500ppm of range)/°C
<b>Frequency Characteristics</b>	DC coupling : DC to 5MHz(-3dB to +1dB) (with LPF OFF) AC coupling : 6Hz to 5MHz(-3dB to +1dB)(with LPF OFF)
<b>Low-pass Filter(LPF)</b>	Cutoff frequency : 5Hz, 50kHz, 500kHz, OFF (-3dB±1dB)
<b>A/D Converter</b>	A/D resolution : 14bit Sampling rate : 20MS/s (max)
<b>Common Mode Rejection Ratio</b>	80dB or higher (50/60Hz)
<b>Allowable Input Voltage</b>	500V peak
<b>Maximum Rated Voltage To Ground</b>	300V AC/DC CATII (between channels, between input terminals and chassis)
<b>Withstand Voltage</b>	3kV AC, 1 minute (between channels, between input terminals and chassis)
<b>Dimensions</b>	Approx. 140 (input-side W) x 223(D) x 20(H) mm
<b>Weight</b>	Approx. 300g
<b>Compliance Standards</b>	Safety : EN61010-1, EN61010-2-30 EMC : EN61326-1, class A

2ch High Voltage Module RA30-107	
<b>Input Channels</b>	2ch
<b>Input Connector</b>	Safety banana socket
<b>Input Type</b>	Isolated unbalanced input (Isolation between each channel, between each channel and main chassis)
<b>Input Coupling</b>	AC, DC, and GND coupling
<b>Input Impedance</b>	4MΩ
<b>Measurement mode</b>	Voltage measurement mode / RMS measurement mode
<b>Response time (when RMS measurement mode)</b>	High speed : 0.1s (within ±10%), Medium speed : 0.25s (within ±10%), Low speed : 1s (within ±10%) *1 All of the above are leading edge 0% → 90% of RANGE, trailing edge 100% → 10% of RANGE
<b>Measurement Range (RANGE)</b>	± 2, 5, 10, 20, 50, 100, 200, 500, 1,000V
<b>Voltage measurement mode:</b>	±0.3% of range (DC coupling, LPF 3Hz)(23°C ±5°C, DC coupling, LPF 3Hz, after zero offset)
<b>When DC coupled</b>	±0.3% of range (DC coupling, LPF 3Hz)(23°C ±5°C, DC coupling, LPF 3Hz, after zero offset)
<b>When AC coupled (Sine wave input)</b>	For low speed response : ±0.5% of RANGE (10Hz to 1kHz input), ±1.5% of RANGE (1kHz to 10kHz input) For medium speed response : ±0.5% of RANGE (40Hz to 1kHz input), ±1.5% of RANGE (1kHz to 10kHz input) For high speed response : ±0.5% of RANGE (100Hz to 1kHz input), ±1.5% of RANGE (1kHz to 10kHz input) *All of the above are at 23°C ±5°C, after zero cancellation.
<b>Temperature Coefficient</b>	± (300ppm of range)/°C
<b>Frequency Response</b>	DC coupling : DC to 100kHz (-3dB to +1dB) (with voltage measurement mode, LPF OFF) AC coupling : 0.3Hz to 100kHz (-3dB to +1dB) (with voltage measurement mode : LPF OFF)
<b>Low-pass Filter(LPF)</b>	Cutoff frequency : 3Hz, 30Hz, 300Hz, 3kHz, OFF (-1.6dB±1dB) Characteristics : 2 pole Bessel type

<b>A/D Converter</b>	A/D resolution : 16bit Sampling rate : 1MS/s (max)
<b>Allowable Input Voltage</b>	±1,000V peak 1,000V AC/DC CATII (between channels, between input terminals and chassis)
<b>Maximum Rated Voltage To Ground</b>	600V AC/DC CATIII (between channels, between input terminals and chassis)
<b>Withstand Voltage</b>	3kV AC, 1 minute (between channels or between input terminals and chassis)
<b>Dimensions</b>	Approx. 140 (input-side W) x 223(D) x 20(H) mm
<b>Weight</b>	Approx. 300g
<b>Compliance Standards</b>	Safety : EN61010-1, EN61010-2-30 EMC : EN61326-1, class A

16ch Logic Module RA30-105	
<b>Input Channels</b>	16ch
<b>I/O Connector</b>	8ch x 2 ports, Input Connector: half-pitch 20pin connector
<b>Input Type</b>	Single input, common input (non-isolated), isolated between input signal and main chassis
<b>Voltage Detection</b>	Input range : 0 to 24V Threshold value : 1.4V (±0.4V)/2.5V (±0.5V)/4V (±0.6V) (selectable from 3 levels) Input Impedance : 1MΩ ±1%
<b>Contact Detection</b>	Threshold (selectable from below 3 levels) Close (High level) : 250 Ω or less/Open (Low level) : 2kΩ or more Close (High level) : 1.5kΩ or less/Open (Low level) : 5kΩ or more Close (High level) : 3kΩ or less/Open (Low level) : 9kΩ or more Load current : 0.5mA (typ.) at load resistance 0 to 18kΩ
<b>Responsive Pulse</b>	2µs or higher
<b>Allowable Input Voltage</b>	30V DC
<b>Maximum Rated Voltage to Ground</b>	42V AC/DC
<b>Withstand Voltage</b>	300V AC, 1 minute (between channels, between input terminals and chassis)
<b>Power Output for Options</b>	For connecting our probe
<b>Dimensions</b>	Approx. 140 (input-side W) x 223(D) x 20(H) mm
<b>Weight</b>	Approx. 250g
<b>Compliance Standards</b>	Safety : EN61010-1, EN61010-2-30 EMC : EN61326-1, class A

2ch Temperature Module RA30-106	
<b>Input Channels</b>	2ch
<b>Input Connector</b>	Removable socket (front panel) Temperature sensor connector coupling wire: 0.2 SQ to 1.5 SQ (AWG24 to AWG16)
<b>Input Type</b>	Isolated unbalanced input (isolation: between channels, between each channel and chassis)
<b>Input Impedance</b>	5MΩ or higher
<b>Adaptive Sensor</b>	Thermocouple : K, E, J, T, N, R, S, B, C (JIS C1602:2015) Resistance temperature detector (RTD) : Pt100, Pt1000 (JIS C1604:2013)

<b>Cold Junction Compensation</b>	Internal/external switching type
<b>Internal Cold Junction Compensation Temp.</b>	±1°C (23°C ±5°C), ±1.5°C (overall temperature range)
<b>Disconnection Detection</b>	ON/OFF switchable

Thermocouple	T/C Type	Measurement Range (RANGE)	Measuring range (°C)	Measurement Accuracy
Thermocouple	K	200°C	-200 to 200	-200 to 0°C± (0.1% of RANGE + 2°C)
		600°C	-200 to 600	0 to 1370°C± (0.1% of RANGE + 1°C)
		1370°C	-200 to 1370	
	E	200°C	-200 to 200	-200 to 0°C± (0.1% of RANGE + 2°C)
		600°C	-200 to 600	0 to 1000°C± (0.1% of RANGE + 1°C)
		1000°C	-200 to 1000	
	J	200°C	-200 to 200	-200 to 0°C± (0.1% of RANGE + 2°C)
		400°C	-200 to 400	0 to 1100°C± (0.1% of RANGE + 1°C)
		1100°C	-200 to 1100	
	T	100°C	-100 to 100	-200 to 0°C± (0.1% of RANGE + 2°C)
		200°C	-200 to 200	0 to 400°C± (0.1% of RANGE + 1°C)
		400°C	-200 to 400	
N	200°C	-200 to 200	-200 to 0°C± (0.1% of RANGE + 2°C)	
	600°C	-200 to 600	0 to 1300°C± (0.1% of RANGE + 1°C)	
	1300°C	-200 to 1300		
R	200°C	0 to 200	0 to 400°C± (0.1% of RANGE + 3.5°C)	
	1000°C	0 to 1000	400 to 1760°C± (0.1% of RANGE + 3°C)	
	1760°C	0 to 1760		
S	200°C	0 to 200	0 to 400°C± (0.1% of RANGE + 3.5°C)	
	1000°C	0 to 1000	400 to 1760°C± (0.1% of RANGE + 3°C)	
	1700°C	0 to 1700		
B	600°C	400 to 600	400 to 1800°C± (0.1% of RANGE + 3°C)	
	1000°C	400 to 1000		
	1800°C	400 to 1800		
C	600°C	0 to 600	0 to 400°C± (0.1% of RANGE + 3.5°C)	
	1200°C	0 to 1200	400 to 2300°C± (0.1% of RANGE + 3°C)	
	2300°C	0 to 2300		

<b>Temperature Coefficient</b>	(Measurement Accuracy × 0.1)/°C			
<b>Measurement Type</b>	3-wire type			
<b>Measurement Current</b>	0.5mA, 1mA switchable (at Pt100), fixed at 0.1mA (at Pt1000)			
<b>Resistance Temperature Detector</b>				
<b>Measurement Range</b>				
Resistance Temperature Detector	Pt100	200°C	-200 to 200	-200 to 850°C ± (0.1% of RANGE ±0.5°C)
		400°C	-200 to 400	
	850°C	-200 to 850		
	Pt1000	200°C	-200 to 200	
		400°C	-200 to 400	
	850°C	-200 to 850		
<b>Temperature Coefficient</b>	(Measurement Accuracy × 0.1)/°C			

<b>A/D Converter</b>	A/D resolution : 16bit Data update rates : high speed (1.5ms), normal speed (100ms), low speed (1s)
<b>Common Mode Rejection Ratio</b>	100dB (Data update: normal speed, low speed), 80dB (Data update: High speed) at 50/60Hz, Signal source resistance 1kΩ
<b>Allowable Input Voltage</b>	30V peak
<b>Maximum Rated Voltage To Earth</b>	300V AC/DC (between channels, between input terminals and chassis)
<b>Withstand Voltage</b>	3kV AC, 1 minute (between channels, between input terminals and chassis)
<b>Dimensions</b>	Approx. 140 (input-side W) x 223(D) x 20(H) mm
<b>Weight</b>	Approx. 300g
<b>Compliance Standards</b>	Safety : EN61010-1, EN61010-2-30 EMC : EN61326-1, class A
<b>Accessories</b>	Temperature sensor connection connector (RA30-555) 2pcs/sets

2ch Frequency Module RA30-108	
<b>Input Channels</b>	2ch
<b>Input Connector</b>	Isolated BNC connector
<b>Input Type</b>	Isolated unbalanced input (Isolation between each channel, between each channel and main chassis)
<b>Input Coupling</b>	AC, DC, and GND coupling
<b>Input Impedance</b>	1MΩ
<b>Measurement Range (RANGE)</b>	Range for the input signal: 1, 2, 5, 10, 20, 50, 100, 200, 500V
<b>Measurement Probability</b>	±3% of RANGE (23°C±5°C, DC coupling, LPF 300Hz) 4 signals
<b>Measurement Signal</b>	Signal 1 : 1ch measurement mode, Signal 3 : 1ch input signal Signal 2 : 2ch measurement mode, Signal 4 : 2ch input signal
<b>Response Speed</b>	OFF, 1 to 1,000ms (1ms steps)
<b>Voltage Range</b>	Variable from -200V to +200V
<b>Hysteresis</b>	1 to 10% of RANGE (1% steps)
<b>Measurement Mode</b>	<b>Period Mode</b>
	<b>Frequency mode</b>
	<b>Rotation speed mode</b>
	<b>Pulse width mode</b>
	<b>Duty ratio mode</b>
	<b>Power frequency mode</b>
	<b>Range of variation mode</b>
	<b>Pulse count mode</b>
	<b>Pulse integration mode</b>
	<b>Deceleration Stop Processing Function</b> (Excluding pulse count mode and pulse integration mode)
<b>Pulse/Rev</b>	
<b>Pulse polarity</b>	
<b>Integration auto-reset</b>	
<b>Pulse averaging processing function</b> (Excluding pulse count mode and pulse integration mode)	
<b>Smoothing process function</b>	
<b>Low-pass Filter(LPF)</b>	
<b>A/D Converter</b>	

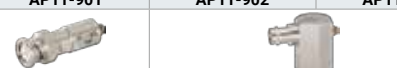
<b>Allowable Input Voltage</b>	±500V peak		
<b>Maximum Rated Voltage To Ground</b>	300V AC/DC CATII (between channels, between input terminals and chassis)		
<b>Withstand Voltage</b>	3kV AC, 1 minute (between channels, between input terminals and chassis)		
<b>Dimensions</b>	Approx. 140 (input-side W) x 223(D) x 20(H) mm		
<b>Weight</b>	Approx. 300g		
<b>Compliance Standards</b>	Safety : EN61010-1, EN61010-2-30 EMC : EN61326-1, class A		
2ch AC Strain Module RA30-104			
<b>Input Channels</b>	2ch		
<b>Input Connector</b>	NDIS4109 Connector (conversion cable sold separately)		
<b>Bridge Voltage (BV)</b>	0.5V AC, 2V AC, 5kV, 5kHz Sine Wave		
<b>Applicable Strain Gauge Resistance</b>	120Ω to 350Ω		
<b>Gauge Rate</b>	2		
<b>Equilibrium adjustment range and adjustment method</b>	Within 10,000 x 10 <sup>-6</sup> strain, within 2,000pF capacitance		
<b>Equilibrium adjustment accuracy</b>	±0.3% of RANGE		
<b>Temperature coefficient</b>	±(400ppm of RANGE)/°C		
<b>Measurement range (RANGE)</b>	500, 1,000, 2,000, 5,000, 10,000, 20,000 x 10 <sup>-6</sup> strain (at 2Vrms bridge power) 2,000, 4,000, 8,000, 20,000, 40,000, 80,000 x 10 <sup>-6</sup> strain (at 0.5Vrms bridge power)		
<b>Non-linearity</b>	±0.1% of RANGE		
<b>Frequency Characteristics</b>	DC to 2kHz ±10%		
<b>Simple Bridge Check</b>	It can detect short-circuits on bridge sides and disconnections of some cables and bridge sides.		
<b>Low-Pass Filter (LPF)</b>	Cutoff frequency : 10Hz, 30Hz, 100Hz, 300Hz, OFF (-3dB±1dB) Characteristics : Secondary Butterworths		
<b>Internal Calibrator</b>	±1 to 9,999 x 10 <sup>-6</sup> strain Accuracy within ±0.5% of RANGE (at 23°C±5°C)		
<b>A/D Converter</b>	A/D resolution : 16bit Sampling rate : 100ks/s (max)		
<b>Maximum Rated Voltage to Ground</b>	100V (DC+ACpeak)		
<b>Withstand voltage</b>	300V AC, 1 minute (between channels, between input terminals and chassis)		
<b>Dimensions</b>	Approx. 140 (input-side W) x 223(D) x 20(H) mm		
<b>Weight</b>	Approx. 300g		
<b>Compliance Standards</b>	Safety : EN61010-1, EN61010-2-30 EMC : EN61326-1, class A		
<b>Note</b>	For AC bridge power supply "Remote control module (RA30-112)" is required.		
2ch Acceleration Module RA30-109			
<b>Input Channels</b>	2ch		
<b>Input Connector</b>	Metal BNC connector		
<b>Input Type</b>	Isolated unbalanced input (Isolation between each channel, between each channel and main chassis)		
<b>Sensor Power Supply</b>	4.2mA±5%, 22.5V±5%		
<b>Sensor sensitivity setting range</b>	0.100 to 100.000mV/(m/s <sup>2</sup> )		
<b>Measurement Mode</b>	Acceleration, speed, displacement		
<b>Measurement range (RANGE)</b>	Measurement range varies depending on sensor sensitivity. Acceleration : 1, 2, 3.16, 5, 10, 20, 31.6, 50, 100, 200, 316, 500m/s <sup>2</sup> , 1, 2, 3.16, 5, 10, 20, 31.6, 50km/s <sup>2</sup> Speed : 10, 20, 31.6, 50, 100, 200, 316, 500mm/s, 1, 2, 3.16, 5, 10, 20, 31.6, 50, 100, 200, 316, 500m/s Displacement : 100, 200, 316, 500mm, 1, 2, 3.16, 5, 10, 20, 31.6, 50, 100, 200, 316, 500mm, 1, 2, 3.16, 5μm		
<b>Measurement Probability</b>	±1% of rdg (In acceleration mode) ±2% of rdg (In speed mode) ±3% of rdg (In displacement mode) *23°C±5°C, sine wave 80Hz, when LPF and AAF are OFF)		
<b>Temperature coefficient</b>	±(300ppm of RANGE) / °C (at acceleration)		
<b>Frequency Characteristics</b>	Acceleration : 5Hz to 20kHz (±0.5dB), 1.5Hz to 50kHz (±1dB), 1Hz to 70kHz (-3dB, ±1dB) Speed : 15.9Hz (0dB±1dB) to 1.59kHz (-40dB±1dB), logarithmic decrement: -6dB/oct Displacement : 15.9Hz (0dB±1dB) to 159Hz (-40dB±1dB), logarithmic decrement : -12dB/oct		
<b>Low-Pass Filter (LPF)</b>	Cutoff frequency : 20Hz, 200Hz, 2kHz, 20kHz, OFF (-3dB±1dB) Characteristics : Tertiary Butterworths		
<b>Anti-aliasing Filter (AAF)</b>	Cutoff frequency : 20, 40, 80, 200, 400, 800, 2k, 4k, 8k, 20k, 40kHz, OFF Attenuation : At 1.5 times the cutoff frequency, -66dB max.		
<b>A/D conversion</b>	Resolution : 16bit Sampling rate : 1MS/s (max)		
<b>Arithmetic Functions</b>	<b>Response Speed</b>	High speed : 0.3s ±10% / medium speed: 0.6s ±10% / low speed : 2.4s ±10%	
	<b>Measurement Probability</b>	At low speed : ±1% of RANGE (10Hz to 1kHz), ±1.5% of RANGE (1kHz to 5kHz) At medium speed : ±1% of RANGE (30Hz to 1kHz), ±1.5% of RANGE (1kHz to 5kHz) At high speed : ±1% of RANGE (50Hz to 1kHz), ±1.5% of RANGE (1kHz to 5kHz)	
<b>Envelope processing</b>	Processing details : Bandpass filter (1kHz to 20kHz) → Absolute value detection → Low-pass filter (1kHz)		
<b>TEDS</b>	IEEE 1451.4 Class1 compliant (Template ID : 25, automatic setting of sensor sensitivity)		
<b>Maximum Rated Voltage To Ground</b>	42V (DC+AC peak)(between channels, between input terminals and chassis)		
<b>Dimensions</b>	Approx. 140 (input-side W) x 223(D) x 20(H) mm		
<b>Weight</b>	Approx. 300g		
<b>Compliance Standards</b>	Safety : EN61010-1, EN61010-2-30 EMC : EN61326-1, class A		
Charge Converter			
<b>Gain</b>	<b>AP11-901</b>	<b>AP11-902</b>	<b>AP11-903</b>
<b>Appearance</b>			
<b>Gain</b>	1.0mV/pC±5%		0.1mV/pC±5%
<b>Max Input Charge</b>	5,000pC		50,000pC
<b>Max. allowable acceleration</b>	Approx 1.6Hz to 50Hz		
<b>Max Output Voltage</b>	5Vp-p or less		
<b>Drive Voltage</b>	12V to 25V DC		
<b>Drive Current</b>	0.5 to 5mA		
<b>Rated Noise</b>	100μVrms or less	20μVrms or less	100μVrms or less
<b>Phase</b>	180°		
<b>Operating Temperature</b>	-20 to 80°C		-20 to 110°C
<b>Connector</b>	Input : Miniature connector (10-32UNF) Output : Metal BNC Connector / Male (AP11-901), Metal BNC connector / Female (AP11-902, AP11-903)		
<b>Dimensions</b>	Φ12 x 38mm		21Hex x 34mm
<b>Weight</b>	Approx. 20g		Approx. 65g
When connecting AP11-902, AP11-903 to the 2ch acceleration module RA30-109, please use the signal cable AS30-504.			

# Main Unit & Accessories

Main Unit		
Item	Model	Specifications
Omniace	RA3100	Standard accessories: AC power cable × 1, recording paper × 1, paper holder × 1 pair, input module slot cover plate × 1 set, quick operation guide × 1, instruction manual CD-ROM × 1

Input Module		
Item	Model	Specifications
2ch Voltage Module*1	RA30-101	Sample rate 1MS/s, Input ±100mV to ±500V, A/D resolution 16bit, Anti-aliasing filter
4ch Voltage Module*1	RA30-102	Sample rate 1MS/s, Input ±1V to ±200V, A/D resolution 16bit
2ch High Speed Voltage Module*1	RA30-103	Sample rate 20MS/s, Input ±100mV to ±500V, A/D resolution 14bit
2ch AC Strain Module*3	RA30-104	2ch, Max. strain input 500 × 10 <sup>-6</sup> strain, AC bridge method, Frequency response DC to 2kHz
16ch Logic Module*5	RA30-105	Input 16ch (voltage or contact)
2ch Temperature Module*4	RA30-106	Data update rate 1.5ms, Thermocouple/RTD, 2 temperature sensor connectors (RA30-555) included
2ch High Voltage Module*2	RA30-107	2ch, max. input ±1,000V, sample rate 1MS/s, RMS conversion
2ch Frequency Module*3	RA30-108	2ch, Pulse input, Input ±500V
2ch Acceleration Module*6	RA30-109	2ch, acceleration transducer (charge output type, voltage output type) input, acceleration, speed, displacement, TEDS compatible
4ch Voltage Module*1	RA30-113	4ch, Sample rate 1MS/s, Input ±2V to ±500V, A/D resolution 16bit

- \*1 Use Isolated BNC cable (Alligator clip) RA30-507
- \*2 Use Alligator clip for High Voltage (RA30-509-01), Connection cable for High Voltage (RA30-509-02).
- \*3 Remote Control Module (RA30-112) is required for 2ch AC Strain Module (RA30-104) to supply AC bridge power. Use NDIS Conversion cable (RA30-508) to connect NDIS connector (NDIS4102).
- \*4 A temperature sensor connector RA30-555 is provided to attach the temperature sensor to the 2ch temperature module.
- \*5 Use 8ch Logic cable (RA30-501, RA30-502, RA30-503), cable for connecting the terminal block (RA30-504).
- \*6 When using Charge converter (AP11-902, AP11-903), use Signal cable (AS30-504).

Control Module		
Item	Model	Specifications
Remote Control Module*7	RA30-112	Remote control, TRIG IN and OUT, and synchronization signal output when AC strain module is used

- \*7 Use a remote control module cable (RA30-505, RA30-506) to connect the remote control module to other devices.

Signal Input Related Options		
Item	Model	Specifications
Isolated BNC Cable (Alligator clip)	RA30-507	1.5m length with an Isolated BNC - safety alligator clip (+red,-black), connected to RA30-101, -102, -103, -108,-113
Alligator clip for High Voltage	RA30-509-01	High voltage alligator clips, CAT III 1,000V, 1 red and 1 black per channel
Connection cable for High Voltage	RA30-509-02	High voltage connection cable 2m, CAT III 1,000V, S-banana plug to S-banana plug, 1 red and 1 black per channel
Extension cable for High Voltage	RA30-509-03	High voltage extension cable 2m, CAT III 1,000V, S-banana jack to S-banana plug, 1 red and 1 black per channel
NDIS Conversion cable	RA30-508	Conversion cable to connect NDIS connector (NDIS4102) of bridge box and strain gage type transducers. For 1ch, length 60cm
Signal cable	AS30-503	2m length, Metal BNC to alligator clip (+red, -black), connected to RA30-109
	AS30-504	2m length, Metal BNC to Metal BNC, connect to RA30-109 and AP11-902/903 charge converter
	0311-5175	2m length, Isolated BNC to alligator clip (+red, -black), connected to RA30-101~103,-108,-113
	0311-5200	2m length, Metal BNC to Isolated BNC, connected to RA30-101~103,-108,-113
8ch Logic Cable (IC clip)	RA30-501	1.5m length for logic input, IC terminal clip (8ch), connected to RA30-105
8ch Logic Cable (Alligator clip)	RA30-502	1.5m length for logic input, electrical terminal clip (8ch), connected to RA30-105
8ch Logic Cable (round type connector converter)	RA30-503	30cm length conversion cable for connection to the RA30-105 from 1539S, 1540S, 1543S
Cable for Terminal Block	RA30-504	2m length, Both ends half-pitch 20p connected to the RA30-105 or RA30-112, attach the MDR20 terminal block AX-PCX-10S20
Remote Control Cable (to connect between main units)	RA30-505	2m length, half-pitch 20p to half-pitch 14p connect the RA30-112 to control with another RA3100 unit each other
Remote Control Cable (without another connector)	RA30-506	2m length, half-pitch 20p to No connector, connected to the RA30-105 or RA30-112
Temperature Sensor Connection Connector	RA30-555	Connector attached to the terminal of temperature sensor connected to the RA30-106, 2 pcs/sets
MDR20 Terminal Block for AD4430C	AX-PCX-10S20	Used as terminal block for IN/OUT of RA30-105, RA30-112 signals
BNC Adaptor*8	0243-3021	Isolated BNC connector and Safety terminal plug, When using Clamp Adaptor (8112), AC/DC Clamp Sensor (8115)
Charge Converter (For Piezoelectric Acceleration Transducer)	AP11-901	Gain 1.0mV/pC, Max Input Charge 5,000pC, Compact type
	AP11-902	Gain 1.0mV/pC, Max Input Charge 5,000pC
	AP11-903	Gain 0.1mV/pC, Max Input Charge 50,000pC, For High Sensitivity Transducer

- \*8 When 2ch AC Strain Module (RA30-102) is installed in an adjacent slot, BNC Adaptor (0243-3021) cannot be installed for all channels.

Options Related to Current and Voltage Measurement		
Item	Model	Specifications
AC/DC Voltage Detector	1539S	4 inputs, AC/DC voltage detector that detects presence of selected low or high voltages and outputs Hi/Lo logic signal
Voltage Fluctuation Detector	1540S	Detects 100/120V AC voltage sags & surges exceeding selected 10% or 20% of AC peak value and outputs as pulse
	1543S	Detects 220/240V AC voltage sags & surges exceeding selected 10% or 20% of AC peak value and outputs as pulse
AC/DC Digital Clamp Meter	2009R*9	For high current (2000A/400A, DC/40 to 1kHz), Φ55, 0311-5184 signal input cable required
Clamp Adaptor	8112*10	For low current (20A/2A/0.2A, 40 to 10kHz), Φ8, 0243-3021 BNC adaptor required
AC/DC Clamp Sensor	8115*10	For low current (AC130A/DC180A, DC/40 to 1kHz), Φ12, 0243-3021 BNC adaptor required
Signal Input Cable for Clamp Meter	0311-5184*11	Length: 2m, miniature plug for microphone and insulated BNC connector

- \*9 Use signal input cable (0311-5184) if connecting output from 2009R to RA3100.
- \*10 Use BNC adaptor (0243-3021) if connecting output from 8112 or 8115 to RA3100.
- \*11 Signal input cable to connect 2009R clamp meter to RA3100 insulated BNC connector.

Recording Paper			
Item	Model	Specifications	
Recording Paper*12	Roll Paper	YPS106	
	Roll Paper (with perforation)	YPS108	219.5mm × 30m roll paper (5 rolls/box), Drawing No. 0511-3167
	Z-fold Paper	YPS112	219.5mm × 30m roll paper (5 rolls/box), perforation 300mm pitch, numbering 99 to 01, Drawing No. 0511-3166
			219.5mm × 201m Z-fold paper (1 set/box), folding width 300mm pitch, total of 670 sheets, Drawing No. 0511-3182

- \*12 Quality not assured if paper other than above is used.

Peripheral Options		
Item	Model	Specifications
SD memory card 4G	RM11-453	4GB, industrial use (for saving setting conditions & measured data)
SD memory card 8G	RM11-454	8GB, industrial use (for saving setting conditions & measured data)
Z-fold Paper Storage Box	RA30-551	Including Z-fold paper adaptor RA12-301
Z-fold Paper Adaptor	RA12-301	
Recording paper holder	5633-1794	2 pcs/sets
Soft Carrying Case	RA23-183	
Hard Carrying Case with Casters	RA30-552	



## Discover Precision

### A&D Company, Ltd.

3-23-14 Higashi-Ikebukuro, Toshima-Ku, Tokyo, 170-0013, Japan Tel: +81 3-5391-6132 Fax: +81 3-5391-1566 <http://www.aandd.jp>

### A&D Engineering, Inc.

1756 Automation Parkway, San Jose, CA 95131, U.S.A. Tel: +1 408-263-5333 Fax: +1 408-263-0119

### A&D Korea Ltd.

8F Manhattan Bldg., 33, Gukjegeumyung-ro 6-gil, Yeongdeungpo-gu, Seoul, 07331, Korea Tel: +82 2-780-4101 Fax: +82 2-782-4280

### A&D Technology Trading Co., Ltd.

32CD, World Plaza, No. 855 South Pudong Road, China (Shanghai) Pilot Free Trade Zone, 200120, China  
Tel: +86 21-3393-2340 Fax: +86 21-3393-2347

### A&D Sciencetech Taiwan Ltd.

4F No. 5 Ching Tao East Road, Taipei, Taiwan, R.O.C. Tel: +886 2-2322-4722 Fax: +886 2-2392-1794